

PHILIPPINE BIDDING DOCUMENTS

Procurement of INFRASTRUCTURE PROJECTS

Government of the Republic of the Philippines

REPAIR OF CLASSROOMS AT DONA AURORA ELEMENTARY SCHOOL

PROCURING ENTITY:

REPUBLIC OF THE PHILIPPINES
DEPARTMENT OF EDUCATION
Cordillera Administrative Region
SCHOOLS DIVISION OF BAGUIO CITY
#82 Military Cut-Off, Baguio City
TeleFax No.: (074) 442-7819

Sixth Edition
July 2020

Preface

These Philippine Bidding Documents (PBDs) for the procurement of Infrastructure Projects (hereinafter referred to also as the “Works”) through Competitive Bidding have been prepared by the Government of the Philippines for use by all branches, agencies, departments, bureaus, offices, or instrumentalities of the government, including government-owned and/or -controlled corporations, government financial institutions, state universities and colleges, local government units, and autonomous regional government. The procedures and practices presented in this document have been developed through broad experience, and are for mandatory use in projects that are financed in whole or in part by the Government of the Philippines or any foreign government/foreign or international financing institution in accordance with the provisions of the 2016 revised Implementing Rules and Regulations (IRR) of Republic Act (RA) No. 9184.

The PBDs are intended as a model for admeasurements (unit prices or unit rates in a bill of quantities) types of contract, which are the most common in Works contracting.

The Bidding Documents shall clearly and adequately define, among others: (i) the objectives, scope, and expected outputs and/or results of the proposed contract; (ii) the eligibility requirements of Bidders; (iii) the expected contract duration; and (iv) the obligations, duties, and/or functions of the winning Bidder.

Care should be taken to check the relevance of the provisions of the PBDs against the requirements of the specific Works to be procured. If duplication of a subject is inevitable in other sections of the document prepared by the Procuring Entity, care must be exercised to avoid contradictions between clauses dealing with the same matter.

Moreover, each section is prepared with notes intended only as information for the Procuring Entity or the person drafting the Bidding Documents. They shall not be included in the final documents. The following general directions should be observed when using the documents:

- a. All the documents listed in the Table of Contents are normally required for the procurement of Infrastructure Projects. However, they should be adapted as necessary to the circumstances of the particular Project.
- b. Specific details, such as the “*name of the Procuring Entity*” and “*address for bid submission*,” should be furnished in the Instructions to Bidders, Bid Data Sheet, and Special Conditions of Contract. The final documents should contain neither blank spaces nor options.
- c. This Preface and the footnotes or notes in italics included in the Invitation to Bid, BDS, General Conditions of Contract, Special Conditions of Contract, Specifications, Drawings, and Bill of Quantities are not part of the text of the final document, although they contain instructions that the Procuring Entity should strictly follow.
- d. The cover should be modified as required to identify the Bidding Documents as to the names of the Project, Contract, and Procuring Entity, in addition to date of issue.

- e. Modifications for specific Procurement Project details should be provided in the Special Conditions of Contract as amendments to the Conditions of Contract. For easy completion, whenever reference has to be made to specific clauses in the Bid Data Sheet or Special Conditions of Contract, these terms shall be printed in bold typeface on Sections I (Instructions to Bidders) and III (General Conditions of Contract), respectively.
- f. For guidelines on the use of Bidding Forms and the procurement of Foreign-Assisted Projects, these will be covered by a separate issuance of the Government Procurement Policy Board.

TABLE OF CONTENTS

Glossary of Terms, Abbreviations, and Acronyms	5
Section I. Invitation to Bid	8
Section II. Instructions to Bidders	11
1. Scope of Bid	12
2. Funding Information	12
3. Bidding Requirements	12
4. Corrupt, Fraudulent, Collusive, Coercive and Obstructive Practices	12
5. Eligible Bidders	12
6. Origin of Associate Goods	13
7. Subcontracts	13
8. Pre-bid Conference	13
9. Clarification and Amendment of Bidding Documents	14
10. Documents Comprising the Bid: Eligibility and Technical Components	14
11. Documents Comprising the Bid: Financial Component	14
12. Alternative Bids	15
13. Bid Prices	15
14. Bid and Payment Currencies	15
15. Bid Security	15
16. Sealing and Making of Bids	15
17. Deadline for Submission of Bids	16
18. Opening and Preliminary Examination of Bids	16
19. Detailed Evaluation and Comparison of Bids	16
20. Post Qualification	16
21. Signing of the Contracts	17
Section III. Bid Data Sheet	18
Section IV. General Conditions of Contract	21
1. Scope of Contract	23
2. Sectional Completion of Works	23
3. Possession of Site	23
4. The Contractor's Obligations	23
5. Performance Security	24
6. Site Investigation Reports	24

7. Warranty	24
8. Liability of the Contractor	24
9. Termination for Other Causes	24
10. Dayworks	25
11. Program of Work	25
12. Instructional, Inspection and Audits	25
13. Advance Payment	25
14. Progress Payments	25
15. Operating and Maintenance Manuals	26
Section V. Special Conditions of Contract	26
Section VI. Specifications	28
Section VII. Drawings	32
Section VIII. Bill of Quantities	33
Section IX. Checklist of Technical and Financial Documents	35

Glossary of Terms, Abbreviations, and Acronyms

ABC – Approved Budget for the Contract.

ARCC – Allowable Range of Contract Cost.

BAC – Bids and Awards Committee.

Bid – A signed offer or proposal to undertake a contract submitted by a bidder in response to and in consonance with the requirements of the bidding documents. Also referred to as *Proposal* and *Tender*. (2016 revised IRR, Section 5[c])

Bidder – Refers to a contractor, manufacturer, supplier, distributor and/or consultant who submits a bid in response to the requirements of the Bidding Documents. (2016 revised IRR, Section 5[d])

Bidding Documents – The documents issued by the Procuring Entity as the bases for bids, furnishing all information necessary for a prospective bidder to prepare a bid for the Goods, Infrastructure Projects, and/or Consulting Services required by the Procuring Entity. (2016 revised IRR, Section 5[e])

BIR – Bureau of Internal Revenue.

BSP – Bangko Sentral ng Pilipinas.

CDA – Cooperative Development Authority.

Consulting Services – Refer to services for Infrastructure Projects and other types of projects or activities of the GOP requiring adequate external technical and professional expertise that are beyond the capability and/or capacity of the GOP to undertake such as, but not limited to: (i) advisory and review services; (ii) pre-investment or feasibility studies; (iii) design; (iv) construction supervision; (v) management and related services; and (vi) other technical services or special studies. (2016 revised IRR, Section 5[i])

Contract – Refers to the agreement entered into between the Procuring Entity and the Supplier or Manufacturer or Distributor or Service Provider for procurement of Goods and Services; Contractor for Procurement of Infrastructure Projects; or Consultant or Consulting Firm for Procurement of Consulting Services; as the case may be, as recorded in the Contract Form signed by the parties, including all attachments and appendices thereto and all documents incorporated by reference therein.

Contractor – is a natural or juridical entity whose proposal was accepted by the Procuring Entity and to whom the Contract to execute the Work was awarded. Contractor as used in these Bidding Documents may likewise refer to a supplier, distributor, manufacturer, or consultant.

CPI – Consumer Price Index.

DOLE – Department of Labor and Employment.

DTI – Department of Trade and Industry.

Foreign-funded Procurement or Foreign-Assisted Project –Refers to procurement whose funding source is from a foreign government, foreign or international financing institution as specified in the Treaty or International or Executive Agreement. (2016 revised IRR, Section 5[b]).

GFI – Government Financial Institution.

GOCC –Government-owned and/or –controlled corporation.

Goods – Refer to all items, supplies, materials and general support services, except Consulting Services and Infrastructure Projects, which may be needed in the transaction of public businesses or in the pursuit of any government undertaking, project or activity, whether in the nature of equipment, furniture, stationery, materials for construction, or personal property of any kind, including non-personal or contractual services such as the repair and maintenance of equipment and furniture, as well as trucking, hauling, janitorial, security, and related or analogous services, as well as procurement of materials and supplies provided by the Procuring Entity for such services. The term “related” or “analogous services” shall include, but is not limited to, lease or purchase of office space, media advertisements, health maintenance services, and other services essential to the operation of the Procuring Entity. (2016 revised IRR, Section 5[r])

GOP – Government of the Philippines.

Infrastructure Projects – Include the construction, improvement, rehabilitation, demolition, repair, restoration or maintenance of roads and bridges, railways, airports, seaports, communication facilities, civil works components of information technology projects, irrigation, flood control and drainage, water supply, sanitation, sewerage and solid waste management systems, shore protection, energy/power and electrification facilities, national buildings, school buildings, hospital buildings, and other related construction projects of the government. Also referred to as *civil works or works*. (2016 revised IRR, Section 5[u])

LGUs – Local Government Units.

NFCC – Net Financial Contracting Capacity.

NGA – National Government Agency.

PCAB – Philippine Contractors Accreditation Board.

PhilGEPS - Philippine Government Electronic Procurement System.

Procurement Project – refers to a specific or identified procurement covering goods, infrastructure project or consulting services. A Procurement Project shall be described, detailed, and scheduled in the Project Procurement Management Plan prepared by the agency which shall be consolidated in the procuring entity's Annual Procurement Plan. (GPPB Circular No. 06-2019 dated 17 July 2019)

PSA – Philippine Statistics Authority.

SEC – Securities and Exchange Commission.

SLCC – Single Largest Completed Contract.

UN – United Nations.

Section I. Invitation to Bid

Notes on the Invitation to Bid

The Invitation to Bid (IB) provides information that enables potential Bidders to decide whether to participate in the procurement at hand. The IB shall be posted in accordance with Section 21.2 of the 2016 revised IRR of RA No. 9184.

Apart from the essential items listed in the Bidding Documents, the IB should also indicate the following:

- a. The date of availability of the Bidding Documents, which shall be from the time the IB is first advertised/posted until the deadline for the submission and receipt of bids;
- b. The place where the Bidding Documents may be acquired or the website where it may be downloaded;
- c. The deadline for the submission and receipt of bids; and
- d. Any important bid evaluation criteria.

The IB should be incorporated into the Bidding Documents. The information contained in the IB must conform to the Bidding Documents and in particular to the relevant information in the Bid Data Sheet.



Republic of the Philippines
Department of Education
Cordillera Administrative Region
SCHOOLS DIVISION OF BAGUIO CITY

Invitation to Bid for

***REPAIR OF CLASSROOMS AT DONA AURORA ELEMENTARY
SCHOOL***

Bid Reference No. 024, s.2024
Approved Budget for the Contract – ₱ 1,000,000.00

1. The *Department of Education, Schools Division of Baguio City*, through the *2024 Basic Educational Facilities Fund (2024 BEFF)* intends to apply the sum of *One million Pesos Only (₱ 1,000,000.00)* being the Approved Budget for the Contract (ABC) to payments under the contract for *Repair of Classrooms at Dona Aurora Elementary School*. Bids received in excess of the ABC shall be automatically rejected at bid opening.
2. The *Department of Education, Schools Division of Baguio City* now invites bids for the above Procurement Project. Completion of the Works is required *61 calendar days*. Bidders should have completed a contract similar to the Project. The description of an eligible bidder is contained in the Bidding Documents, particularly, in Section II (Instructions to Bidders).
3. Bidding will be conducted through open competitive bidding procedures using non-discretionary “*pass/fail*” criterion as specified in the 2016 revised Implementing Rules and Regulations (IRR) of Republic Act (RA) No. 9184.
4. Interested bidders may obtain further information from *Department of Education, Schools Division of Baguio City, #82 Military Cut-Off, Baguio City* and inspect the Bidding Documents at www.depedpines.com or the address given during *Monday to Friday from 8:00 AM - 5:00 PM*.
5. A complete set of Bidding Documents may be acquired by interested bidders from *October 1, 2024* on the given address and website/s below *and upon payment of the applicable fee for the Bidding Documents, pursuant to the latest Guidelines issued by the GPPB, in the amount of One Thousand Pesos Only (P 1,000.00)*. The Procuring Entity shall allow the bidder to present its proof of payment for the *fees personally or by electronic means through the agency’s Landbank Account with account no. 0222-0209-64 but must first acquire an order of payment from the agency through (074) 442-7819*.
6. The *Department of Education, Schools Division of Baguio City* will hold a Pre-Bid Conference¹ on *October 9, 2024, 10:00 AM* at *Department of Education, Schools Division of Baguio City Conference Hall, # 82 Military Cut-Off, Baguio City* and/or through videoconferencing/webcasting *via Zoom Video Conferencing through the link [:https://tinyurl.com/depedbaguiobac](https://tinyurl.com/depedbaguiobac)*, which shall be open to prospective bidders.
7. Bids must be duly received by the BAC Secretariat through: (i) manual submission at the office address as indicated below, (ii) online or electronic submission as indicated below, or (iii) both on or before *October 21, 2024, 9:45 AM*. Late bids shall not be accepted.

¹ May be deleted in case the ABC is less than One Million Pesos (PhP1,000,000) where the Procuring Entity may not hold a pre-bid conference.

8. All bids must be accompanied by a bid security in any of the acceptable forms and in the amount stated in **ITB** Clause 16.
9. Bid opening shall be on **October 21, 2024, 10:00 AM** at *DepEd, Schools Division of Baguio City Conference Hall, # 82 Military Cut-Off, Baguio City* and/or through Zoom Video Conferencing through the link :<https://tinyurl.com/depedbagueiobac>. Bids will be opened in the presence of the bidders' representatives who choose to attend the activity.
10. *Bidders are advised to log in to the Zoom Video Conferencing through the link :<https://tinyurl.com/depedbagueiobac> and wait for further advice to join the BAC meeting.*
11. The **Department of Education, Schools Division of Baguio City** reserves the right to reject any and all bids, declare a failure of bidding, or not award the contract at any time prior to contract award in accordance with Sections 35.6 and 41 of the 2016 revised Implementing Rules and Regulations (IRR) of RA No. 9184, without thereby incurring any liability to the affected bidder or bidders.
12. For further information, please refer to:

CARMEL F. MERIS

BAC Chairperson

Department of Education, Schools Division of Baguio City

Address: # 82 Military Cut-Off, Baguio City

Email Add: depedbagueiocity@gmail.com

Telefax No.:(074) 442 – 7819

Website: www.depedpines.com

13. You may visit the following websites:

For downloading of Bidding Documents:www.depedpines.com

For online bid submission:depedbagueiocity@gmail.com
Cc: depedbagueiobac@gmail.com

September 30, 2024

CARMEL F. MERIS

BAC Chairperson

For the BAC Chairperson

NINO M. TIBANGAY

BAC Vice Chairperson

Section II. Instructions to Bidders

Notes on the Instructions to Bidders

This Section on the Instruction to Bidders (ITB) provides the information necessary for bidders to prepare responsive bids, in accordance with the requirements of the Procuring Entity. It also provides information on bid submission, eligibility check, opening and evaluation of bids, post-qualification, and on the award of contract.

1. **Scope of Bid**

The Procuring Entity, *Department of Education, Schools Division of Baguio City* invites Bids for the *Repair of Classrooms at Dona Aurora Elementary School*, with Project Identification Number *Bid Reference No. 024, s. 2024*.

The Procurement Project (referred to herein as “Project”) is for the construction of Works, as described in Section VI (Specifications).

2. **Funding Information**

2.1. The GOP through the source of funding as indicated below for *2024 Basic Educational Facilities Fund* in the amount of *One million pesos only (Php.1,000,000.00)*

2.2. The source of funding is:

a. NGA, *Basic Educational Facilities Fund*.

3. **Bidding Requirements**

The Bidding for the Project shall be governed by all the provisions of RA No. 9184 and its 2016 revised IRR, including its Generic Procurement Manual and associated policies, rules and regulations as the primary source thereof, while the herein clauses shall serve as the secondary source thereof.

Any amendments made to the IRR and other GPPB issuances shall be applicable only to the ongoing posting, advertisement, or invitation to bid by the BAC through the issuance of a supplemental or bid bulletin.

The Bidder, by the act of submitting its Bid, shall be deemed to have inspected the site, determined the general characteristics of the contracted Works and the conditions for this Project, such as the location and the nature of the work; (b) climatic conditions; (c) transportation facilities; (c) nature and condition of the terrain, geological conditions at the site communication facilities, requirements, location and availability of construction aggregates and other materials, labor, water, electric power and access roads; and (d) other factors that may affect the cost, duration and execution or implementation of the contract, project, or work and examine all instructions, forms, terms, and project requirements in the Bidding Documents.

4. **Corrupt, Fraudulent, Collusive, Coercive, and Obstructive Practices**

The Procuring Entity, as well as the Bidders and Contractors, shall observe the highest standard of ethics during the procurement and execution of the contract. They or through an agent shall not engage in corrupt, fraudulent, collusive, coercive, and obstructive practices defined under Annex “I” of the 2016 revised IRR of RA No. 9184 or other integrity violations in competing for the Project.

5. **Eligible Bidders**

- 5.1. Only Bids of Bidders found to be legally, technically, and financially capable will be evaluated.
- 5.2. The Bidder must have an experience of having completed a Single Largest Completed Contract (SLCC) that is similar to this Project, equivalent to at least fifty percent (50%) of the ABC adjusted, if necessary, by the Bidder to current prices using the PSA's CPI, except under conditions provided for in Section 23.4.2.4 of the 2016 revised IRR of RA No. 9184.

A contract is considered to be "similar" to the contract to be bid if it has the major categories of work stated in the **BDS**.
- 5.3. For Foreign-funded Procurement, the Procuring Entity and the foreign government/foreign or international financing institution may agree on another track record requirement, as specified in the Bidding Document prepared for this purpose.
- 5.4. The Bidders shall comply with the eligibility criteria under Section 23.4.2 of the 2016 IRR of RA No. 9184.

6. Origin of Associated Goods

There is no restriction on the origin of Goods other than those prohibited by a decision of the UN Security Council taken under Chapter VII of the Charter of the UN.

7. Subcontracts

- 7.1. The Bidder may subcontract portions of the Project to the extent allowed by the Procuring Entity as stated herein, but in no case more than fifty percent (50%) of the Project.

The Procuring Entity has prescribed that:

- a. Subcontracting is not allowed.
- 7.2. Subcontracting of any portion of the Project does not relieve the Contractor of any liability or obligation under the Contract. The Supplier will be responsible for the acts, defaults, and negligence of any subcontractor, its agents, servants, or workmen as fully as if these were the Contractor's own acts, defaults, or negligence, or those of its agents, servants, or workmen.

8. Pre-Bid Conference

The Procuring Entity will hold a pre-bid conference for this Project on the specified date and time and either at its physical address, **October 9, 2024** at *Department of Education, Schools Division of Baguio City Conference Hall, # 82 Military Cut-Off, Baguio City* and/or through videoconferencing/webcasting } as indicated in paragraph 6 of the **IB**.

9. Clarification and Amendment of Bidding Documents

Prospective bidders may request for clarification on and/or interpretation of any part of the Bidding Documents. Such requests must be in writing and received by the Procuring Entity, either at its given address or through electronic mail indicated in the **IB**, at least ten (10) calendar days before the deadline set for the submission and receipt of Bids.

10. Documents Comprising the Bid: Eligibility and Technical Components

- 10.1. The first envelope shall contain the eligibility and technical documents of the Bid as specified in **Section IX. Checklist of Technical and Financial Documents**.
- 10.2. If the eligibility requirements or statements, the bids, and all other documents for submission to the BAC are in foreign language other than English, it must be accompanied by a translation in English, which shall be authenticated by the appropriate Philippine foreign service establishment, post, or the equivalent office having jurisdiction over the foreign bidder's affairs in the Philippines. For Contracting Parties to the Apostille Convention, only the translated documents shall be authenticated through an apostille pursuant to GPPB Resolution No. 13-2019 dated 23 May 2019. The English translation shall govern, for purposes of interpretation of the bid.
- 10.3. A valid special PCAB License in case of Joint Ventures, and registration for the type and cost of the contract for this Project. Any additional type of Contractor license or permit shall be indicated in the **BDS**.
- 10.4. A List of Contractor's key personnel (e.g., Project Manager, Project Engineers, Materials Engineers, and Foremen) assigned to the contract to be bid, with their complete qualification and experience data shall be provided. These key personnel must meet the required minimum years of experience set in the **BDS**.
- 10.5. A List of Contractor's major equipment units, which are owned, leased, and/or under purchase agreements, supported by proof of ownership, certification of availability of equipment from the equipment lessor/vendor for the duration of the project, as the case may be, must meet the minimum requirements for the contract set in the **BDS**.

11. Documents Comprising the Bid: Financial Component

- 11.1. The second bid envelope shall contain the financial documents for the Bid as specified in **Section IX. Checklist of Technical and Financial Documents**.
- 11.2. Any bid exceeding the ABC indicated in paragraph 1 of the **IB** shall not be accepted.

- 11.3. For Foreign-funded procurement, a ceiling may be applied to bid prices provided the conditions are met under Section 31.2 of the 2016 revised IRR of RA No. 9184.

12. Alternative Bids

Bidders shall submit offers that comply with the requirements of the Bidding Documents, including the basic technical design as indicated in the drawings and specifications. Unless there is a value engineering clause in the **BDS**, alternative Bids shall not be accepted.

13. Bid Prices

All bid prices for the given scope of work in the Project as awarded shall be considered as fixed prices, and therefore not subject to price escalation during contract implementation, except under extraordinary circumstances as determined by the NEDA and approved by the GPPB pursuant to the revised Guidelines for Contract Price Escalation guidelines.

14. Bid and Payment Currencies

14.1. Bid prices may be quoted in the local currency or tradeable currency accepted by the BSP at the discretion of the Bidder. However, for purposes of bid evaluation, Bids denominated in foreign currencies shall be converted to Philippine currency based on the exchange rate as published in the BSP reference rate bulletin on the day of the bid opening.

14.2. *Payment of the contract price shall be made in:*

- a. Philippine Pesos.

15. Bid Security

15.1. The Bidder shall submit a Bid Securing Declaration or any form of Bid Security in the amount indicated in the **BDS**, which shall be not less than the percentage of the ABC in accordance with the schedule in the **BDS**.

15.2. The Bid and bid security shall be valid until *120 calendar days reckoned from the date of the opening of bid(s). Bid(s) with bid security valid for a shorter period shall be rejected outright as non-responsive..* Any bid not accompanied by an acceptable bid security shall be rejected by the Procuring Entity as non-responsive.

16. Sealing and Marking of Bids

Each Bidder shall submit one copy of the first and second components of its Bid.

The Procuring Entity may request additional hard copies and/or electronic copies of the Bid. However, failure of the Bidders to comply with the said request shall not be a ground for disqualification.

If the Procuring Entity allows the submission of bids through online submission to the given website or any other electronic means, the Bidder shall submit an electronic copy of its Bid, which must be digitally signed. An electronic copy that cannot be opened or is corrupted shall be considered non-responsive and, thus, automatically disqualified.

17. Deadline for Submission of Bids

The Bidders shall submit on the specified date and time and either at its physical address or through online submission as indicated in paragraph 7 of the **IB**.

18. Opening and Preliminary Examination of Bids

18.1. The BAC shall open the Bids in public at the time, on the date, and at the place specified in paragraph 9 of the **IB**. The Bidders' representatives who are present shall sign a register evidencing their attendance. In case videoconferencing, webcasting or other similar technologies will be used, attendance of participants shall likewise be recorded by the BAC Secretariat.

In case the Bids cannot be opened as scheduled due to justifiable reasons, the rescheduling requirements under Section 29 of the 2016 revised IRR of RA No. 9184 shall prevail.

18.2. The preliminary examination of Bids shall be governed by Section 30 of the 2016 revised IRR of RA No. 9184.

19. Detailed Evaluation and Comparison of Bids

19.1. The Procuring Entity's BAC shall immediately conduct a detailed evaluation of all Bids rated "*passed*" using non-discretionary pass/fail criteria. The BAC shall consider the conditions in the evaluation of Bids under Section 32.2 of 2016 revised IRR of RA No. 9184.

19.2. If the Project allows partial bids, all Bids and combinations of Bids as indicated in the **BDS** shall be received by the same deadline and opened and evaluated simultaneously so as to determine the Bid or combination of Bids offering the lowest calculated cost to the Procuring Entity. Bid Security as required by **ITB** Clause 15 shall be submitted for each contract (lot) separately.

19.3. In all cases, the NFCC computation pursuant to Section 23.4.2.6 of the 2016 revised IRR of RA No. 9184 must be sufficient for the total of the ABCs for all the lots participated in by the prospective Bidder.

20. Post Qualification

Within a non-extendible period of five (5) calendar days from receipt by the Bidder of the notice from the BAC that it submitted the Lowest Calculated Bid, the Bidder shall submit its latest income and business tax returns filed and paid through the BIR Electronic Filing and Payment System (eFPS), and other appropriate licenses and permits required by law and stated in the **BDS**.

21. Signing of the Contract

The documents required in Section 37.2 of the 2016 revised IRR of RA No. 9184 shall form part of the Contract. Additional Contract documents are indicated in the **BDS**.

Section III. Bid Data Sheet

Notes on the Bid Data Sheet (BDS)

The Bid Data Sheet (BDS) consists of provisions that supplement, amend, or specify in detail, information, or requirements included in the ITB found in Section II, which are specific to each procurement.

This Section is intended to assist the Procuring Entity in providing the specific information in relation to corresponding clauses in the ITB and has to be prepared for each specific procurement.

The Procuring Entity should specify in the BDS information and requirements specific to the circumstances of the Procuring Entity, the processing of the procurement, and the bid evaluation criteria that will apply to the Bids. In preparing the BDS, the following aspects should be checked:

- a. Information that specifies and complements provisions of the ITB must be incorporated.
- b. Amendments and/or supplements, if any, to provisions of the ITB as necessitated by the circumstances of the specific procurement, must also be incorporated.

Bid Data Sheet

ITB Clause																			
5.2	<p>For this purpose, contracts similar to the Project refer to contracts which have the same major categories of work, which shall be:</p> <p>1. Building Construction/Rehabilitation</p> <p style="text-align: center;"><i>Repair of Classrooms at Dona Aurora Elementary School.</i></p>																		
7.1	<i>Subcontracting is not allowed.</i>																		
10.3	<p><i>Philippine Contractors Accreditation Board (PCAB) License: Minimum requirement of</i></p> <p><i>General Engineering D or higher , Category Small B or higher (Building and industrial plants)</i></p>																		
10.4	<p>The key personnel must meet the required minimum years of experience set below:</p> <table style="width: 100%; border-collapse: collapse;"> <thead> <tr> <th style="text-align: left;"><u>Key Personnel</u></th> <th style="text-align: center;"><u>General Experience</u></th> <th style="text-align: center;"><u>Relevant Experience</u></th> </tr> </thead> <tbody> <tr> <td>1. Project Engineer</td> <td style="text-align: center;">2 years</td> <td style="text-align: center;">2 years</td> </tr> <tr> <td>2. Project Foreman</td> <td style="text-align: center;">2 years</td> <td style="text-align: center;">1 years</td> </tr> <tr> <td>3. Skilled Laborers</td> <td></td> <td></td> </tr> <tr> <td>4. Laborers</td> <td></td> <td></td> </tr> </tbody> </table> <p>1. Project Foreman must be present onsite on all working days. 2. General experience refers to the years of experience regardless of task assigned a personnel in a construction project while Relevant experience refers to the personnel’s experience in the particular task required</p>	<u>Key Personnel</u>	<u>General Experience</u>	<u>Relevant Experience</u>	1. Project Engineer	2 years	2 years	2. Project Foreman	2 years	1 years	3. Skilled Laborers			4. Laborers					
<u>Key Personnel</u>	<u>General Experience</u>	<u>Relevant Experience</u>																	
1. Project Engineer	2 years	2 years																	
2. Project Foreman	2 years	1 years																	
3. Skilled Laborers																			
4. Laborers																			
10.5	<p>The minimum major equipment requirements are the following:</p> <table style="width: 100%; border-collapse: collapse;"> <thead> <tr> <th style="text-align: left;"><u>Equipment</u></th> <th style="text-align: center;"><u>Number of Units</u></th> </tr> </thead> <tbody> <tr> <td></td> <td style="text-align: center;">at least:</td> </tr> <tr> <td>Dumptruck (3 cu.m. cap)</td> <td style="text-align: center;">1 unit</td> </tr> <tr> <td>Electric Jackhammer</td> <td style="text-align: center;">1 unit</td> </tr> <tr> <td>Welding machine</td> <td style="text-align: center;">1 unit</td> </tr> <tr> <td>Electric Grinder</td> <td style="text-align: center;">1 unit</td> </tr> <tr> <td>Jackhammer Drill</td> <td style="text-align: center;">1 Unit</td> </tr> <tr> <td>H-frame 1.7 m. x 1.20m.</td> <td style="text-align: center;">1 lot</td> </tr> <tr> <td>G. I. Pipe scaffolds</td> <td style="text-align: center;">1 lot</td> </tr> </tbody> </table> <p>* Pledged equipment must be available on site upon post qualification and evaluation of TWG.</p>	<u>Equipment</u>	<u>Number of Units</u>		at least:	Dumptruck (3 cu.m. cap)	1 unit	Electric Jackhammer	1 unit	Welding machine	1 unit	Electric Grinder	1 unit	Jackhammer Drill	1 Unit	H-frame 1.7 m. x 1.20m.	1 lot	G. I. Pipe scaffolds	1 lot
<u>Equipment</u>	<u>Number of Units</u>																		
	at least:																		
Dumptruck (3 cu.m. cap)	1 unit																		
Electric Jackhammer	1 unit																		
Welding machine	1 unit																		
Electric Grinder	1 unit																		
Jackhammer Drill	1 Unit																		
H-frame 1.7 m. x 1.20m.	1 lot																		
G. I. Pipe scaffolds	1 lot																		
12	<p><i>Alternative Bids – Value Engineering</i></p> <p>No further instructions.</p>																		
	For purpose of Post Qualification, the bidder shall attached the following on																		

12.1.	<p>their technical documents upon submission of bid proposal:</p> <p><i>Documents.</i></p> <p>(a) <i>Registration certificate from the Securities and Exchange Commission (SEC) , Department of Trade and Industry (DTI) for sole proprietorship, or CDA for cooperatives;</i></p> <p>(b) <i>Mayor’s Business permit issued by the local government where the principal place of business of the bidder is located; and</i></p> <p>(c) <i>Audited Financial Statements showing, among others, the prospective bidder’s total and current assets and liabilities stamped “received” by the Bureau of Internal Revenue or its duly accredited and authorized institutions, for the preceding calendar year which should not be earlier than two years from the date of submission.</i></p> <p>(d) <i>Tax Clearance per Executive Order 398, series of 2005, as finally reviewed and approved by BIR</i></p>
15.1	<p>The bid security shall be in the form of a Bid Securing Declaration or any of the following forms and amounts:</p> <p>a. The amount of not less than <i>twenty thousand pesos only (₱ 20,000.00)</i>, if bid security is in cash, cashier’s/manager’s check, bank draft/guarantee or irrevocable letter of credit;</p> <p>b. The amount of not less than <i>fifty thousand pesos only (₱ 50,000.00)</i>, if bid security is in Surety Bond.</p>
16	<p>Each Bidder shall submit <i>one (1)</i> original and <i>two (2)</i> copy of the first and second components of its bid. The original shall be marked “ORIGINAL BID” and the copies shall be “COPY 1” and “COPY 2” . These two (3) envelopes shall be placed in one single envelope (mother envelope).</p> <p>ORIGINAL BID – contains the Original Technical and Financial documents (for BAC copy).</p> <p>COPY 1 – contains Copy 1 of Technical and Financial Documents (for COA)</p> <p>COPY 2 – contains Copy 2 of Technical and Financial Documents (for Educational Facilities Section)</p> <p>Note: The bidder must affix his signature on the seal/closure of ALL the envelopes.</p>
19.2	<p>Partial bid is not allowed. The infrastructure project is packaged in a single lot and the lot shall not be divided into sub-lots for the purpose of bidding, evaluation, and contract award.</p> <p>In all cases, the NFCC computation, if applicable, must be sufficient for all the lots or contracts to be awarded to the Bidder.</p>
20	No Further instructions.

21	<p>Additional contract documents relevant to the Project that may be required by existing laws and/or the Procuring Entity, such as construction schedule and S-curve, manpower schedule, construction methods, equipment utilization schedule, construction safety and health program approved by the DOLE, and other acceptable tools of project scheduling.</p> <p>The winning bidder shall secure and submit Construction Safety and Health Procedure Certificate approved by the Department of Labor and Employment (COSH).</p>

Section IV. General Conditions of Contract

Notes on the General Conditions of Contract

The General Conditions of Contract (GCC) in this Section, read in conjunction with the Special Conditions of Contract in Section V and other documents listed therein, should be a complete document expressing all the rights and obligations of the parties.

Matters governing performance of the Contractor, payments under the contract, or matters affecting the risks, rights, and obligations of the parties under the contract are included in the GCC and Special Conditions of Contract.

Any complementary information, which may be needed, shall be introduced only through the Special Conditions of Contract.

1. Scope of Contract

This Contract shall include all such items, although not specifically mentioned, that can be reasonably inferred as being required for its completion as if such items were expressly mentioned herein. All the provisions of RA No. 9184 and its 2016 revised IRR, including the Generic Procurement Manual, and associated issuances, constitute the primary source for the terms and conditions of the Contract, and thus, applicable in contract implementation. Herein clauses shall serve as the secondary source for the terms and conditions of the Contract.

This is without prejudice to Sections 74.1 and 74.2 of the 2016 revised IRR of RA No. 9184 allowing the GPPB to amend the IRR, which shall be applied to all procurement activities, the advertisement, posting, or invitation of which were issued after the effectivity of the said amendment.

2. Sectional Completion of Works

If sectional completion is specified in the **Special Conditions of Contract (SCC)**, references in the Conditions of Contract to the Works, the Completion Date, and the Intended Completion Date shall apply to any Section of the Works (other than references to the Completion Date and Intended Completion Date for the whole of the Works).

3. Possession of Site

3.1 The Procuring Entity shall give possession of all or parts of the Site to the Contractor based on the schedule of delivery indicated in the **SCC**, which corresponds to the execution of the Works. If the Contractor suffers delay or incurs cost from failure on the part of the Procuring Entity to give possession in accordance with the terms of this clause, the Procuring Entity's Representative shall give the Contractor a Contract Time Extension and certify such sum as fair to cover the cost incurred, which sum shall be paid by Procuring Entity.

3.2 If possession of a portion is not given by the above date, the Procuring Entity will be deemed to have delayed the start of the relevant activities. The resulting adjustments in contract time to address such delay may be addressed through contract extension provided under Annex "E" of the 2016 revised IRR of RA No. 9184.

4. The Contractor's Obligations

The Contractor shall employ the key personnel named in the Schedule of Key Personnel indicating their designation, in accordance with **ITB** Clause 10.3 and specified in the **BDS**, to carry out the supervision of the Works.

The Procuring Entity will approve any proposed replacement of key personnel only if their relevant qualifications and abilities are equal to or better than those of the personnel listed in the Schedule.

5. Performance Security

- 5.1. Within ten (10) calendar days from receipt of the Notice of Award from the Procuring Entity but in no case later than the signing of the contract by both parties, the successful Bidder shall furnish the performance security in any of the forms prescribed in Section 39 of the 2016 revised IRR.
- 5.2. The Contractor, by entering into the Contract with the Procuring Entity, acknowledges the right of the Procuring Entity to institute action pursuant to RA No. 3688 against any subcontractor be they an individual, firm, partnership, corporation, or association supplying the Contractor with labor, materials and/or equipment for the performance of this Contract.

6. Site Investigation Reports

The Contractor, in preparing the Bid, shall rely on any Site Investigation Reports referred to in the **SCC** supplemented by any information obtained by the Contractor.

7. Warranty

- 7.1. In case the Contractor fails to undertake the repair works under Section 62.2.2 of the 2016 revised IRR, the Procuring Entity shall forfeit its performance security, subject its property(ies) to attachment or garnishment proceedings, and perpetually disqualify it from participating in any public bidding. All payables of the GOP in his favor shall be offset to recover the costs.
- 7.2. The warranty against Structural Defects/Failures, except that occasioned-on force majeure, shall cover the period from the date of issuance of the Certificate of Final Acceptance by the Procuring Entity. Specific duration of the warranty is found in the **SCC**.

8. Liability of the Contractor

Subject to additional provisions, if any, set forth in the **SCC**, the Contractor's liability under this Contract shall be as provided by the laws of the Republic of the Philippines.

If the Contractor is a joint venture, all partners to the joint venture shall be jointly and severally liable to the Procuring Entity.

9. Termination for Other Causes

Contract termination shall be initiated in case it is determined *prima facie* by the Procuring Entity that the Contractor has engaged, before, or during the implementation of the contract, in unlawful deeds and behaviors relative to contract acquisition and implementation, such as, but not limited to corrupt, fraudulent, collusive, coercive, and obstructive practices as stated in **ITB** Clause 4.

10. Dayworks

Subject to the guidelines on Variation Order in Annex “E” of the 2016 revised IRR of RA No. 9184, and if applicable as indicated in the SCC, the Dayworks rates in the Contractor’s Bid shall be used for small additional amounts of work only when the Procuring Entity’s Representative has given written instructions in advance for additional work to be paid for in that way.

11. Program of Work

11.1. The Contractor shall submit to the Procuring Entity’s Representative for approval the said Program of Work showing the general methods, arrangements, order, and timing for all the activities in the Works. The submissions of the Program of Work are indicated in the SCC.

11.2. The Contractor shall submit to the Procuring Entity’s Representative for approval an updated Program of Work at intervals no longer than the period stated in the SCC. If the Contractor does not submit an updated Program of Work within this period, the Procuring Entity’s Representative may withhold the amount stated in the SCC from the next payment certificate and continue to withhold this amount until the next payment after the date on which the overdue Program of Work has been submitted.

12. Instructions, Inspections and Audits

The Contractor shall permit the GOP or the Procuring Entity to inspect the Contractor’s accounts and records relating to the performance of the Contractor and to have them audited by auditors of the GOP or the Procuring Entity, as may be required.

13. Advance Payment

The Procuring Entity shall, upon a written request of the Contractor which shall be submitted as a Contract document, make an advance payment to the Contractor in an amount not exceeding fifteen percent (15%) of the total contract price, to be made in lump sum, or at the most two installments according to a schedule specified in the SCC, subject to the requirements in Annex “E” of the 2016 revised IRR of RA No. 9184.

14. Progress Payments

The Contractor may submit a request for payment for Work accomplished. Such requests for payment shall be verified and certified by the Procuring Entity’s Representative/Project Engineer. Except as otherwise stipulated in the SCC, materials and equipment delivered on the site but not completely put in place shall not be included for payment.

15. Operating and Maintenance Manuals

- 15.1. If required, the Contractor will provide “as built” Drawings and/or operating and maintenance manuals as specified in the **SCC**.
- 15.2. If the Contractor does not provide the Drawings and/or manuals by the dates stated above, or they do not receive the Procuring Entity’s Representative’s approval, the Procuring Entity’s Representative may withhold the amount stated in the **SCC** from payments due to the Contractor.

Section V. Special Conditions of Contract

Notes on the Special Conditions of Contract

Similar to the BDS, the clauses in this Section are intended to assist the Procuring Entity in providing contract-specific information in relation to corresponding clauses in the GCC found in Section IV.

The Special Conditions of Contract (SCC) complement the GCC, specifying contractual requirements linked to the special circumstances of the Procuring Entity, the Procuring Entity's country, the sector, and the Works procured. In preparing this Section, the following aspects should be checked:

- a. Information that complements provisions of the GCC must be incorporated.
- b. Amendments and/or supplements to provisions of the GCC as necessitated by the circumstances of the specific purchase, must also be incorporated.

However, no special condition which defeats or negates the general intent and purpose of the provisions of the GCC should be incorporated herein.

Special Conditions of Contract

GCC Clause	
2	The Intended Completion Date is 61 calendar days after acceptance of Notice to Proceed.
4.1	The Procuring Entity shall give possession of all parts of the Site to the Contractor after a pre-construction meeting between the authorized representatives of the Procuring Entity and the Contractor.
6	The site investigation reports are: None
7.2	Fifteen (15) years.
10	a. Dayworks are applicable at the rate shown in the Contractor's original Bid.
11.1	The Contractor shall submit the Program of Work to the Procuring Entity's Representative within <i>ten (10) days</i> of delivery of the Notice of Award.
11.2	The amount to be withheld for late submission of an updated Program of Work is 5% of the Progress Billing.
13	The amount of the advance payment is <i>15% of the Contract Price upon issuance of the Notice to Proceed. Also, manpower and functional equipment, materials and project billboard must be available on site.</i>
14	Materials and equipment delivered on the site but not completely put in place shall NOT be included for payment.
15.1	The date by which operating and maintenance manuals are required is <i>upon the release of Certificate of Final Inspection issued by the implementing agency.</i> The date by which "as built" drawings are required is <i>during the construction phase or after the final inspection.</i>
15.2	The amount to be withheld for failing to produce "as built" drawings and/or operating and maintenance manuals by the date required is <i>10 % of the contractor's bid price.</i>

Section VI. Specifications

Notes on Specifications

A set of precise and clear specifications is a prerequisite for Bidders to respond realistically and competitively to the requirements of the Procuring Entity without qualifying or conditioning their Bids. In the context of international competitive bidding, the specifications must be drafted to permit the widest possible competition and, at the same time, present a clear statement of the required standards of workmanship, materials, and performance of the goods and services to be procured. Only if this is done will the objectives of economy, efficiency, and fairness in procurement be realized, responsiveness of Bids be ensured, and the subsequent task of bid evaluation facilitated. The specifications should require that all goods and materials to be incorporated in the Works be new, unused, of the most recent or current models, and incorporate all recent improvements in design and materials unless provided otherwise in the Contract.

Samples of specifications from previous similar projects are useful in this respect. The use of metric units is mandatory. Most specifications are normally written specially by the Procuring Entity or its representative to suit the Works at hand. There is no standard set of Specifications for universal application in all sectors in all regions, but there are established principles and practices, which are reflected in these PBDs.

There are considerable advantages in standardizing General Specifications for repetitive Works in recognized public sectors, such as highways, ports, railways, urban housing, irrigation, and water supply, in the same country or region where similar conditions prevail. The General Specifications should cover all classes of workmanship, materials, and equipment commonly involved in construction, although not necessarily to be used in a particular Works Contract. Deletions or addenda should then adapt the General Specifications to the particular Works.

Care must be taken in drafting specifications to ensure that they are not restrictive. In the specification of standards for goods, materials, and workmanship, recognized international standards should be used as much as possible. Where other particular standards are used, whether national standards or other standards, the specifications should state that goods, materials, and workmanship that meet other authoritative standards, and which ensure substantially equal or higher quality than the standards mentioned, will also be acceptable. The following clause may be inserted in the SCC.

Sample Clause: Equivalency of Standards and Codes

Wherever reference is made in the Contract to specific standards and codes to be met by the goods and materials to be furnished, and work performed or tested, the provisions of the latest current edition or revision of the relevant standards and codes in effect shall apply, unless otherwise expressly stated in the Contract. Where such standards and codes

are national, or relate to a particular country or region, other authoritative standards that ensure a substantially equal or higher quality than the standards and codes specified will be accepted subject to the Procuring Entity's Representative's prior review and written consent. Differences between the standards specified and the proposed alternative standards shall be fully described in writing by the Contractor and submitted to the Procuring Entity's Representative at least twenty-eight (28) days prior to the date when the Contractor desires the Procuring Entity's Representative's consent. In the event the Procuring Entity's Representative determines that such proposed deviations do not ensure substantially equal or higher quality, the Contractor shall comply with the standards specified in the documents.

These notes are intended only as information for the Procuring Entity or the person drafting the Bidding Documents. They should not be included in the final Bidding Documents.

- Division Procurement Implementation Team (DPRIT), Division Inspectorate Team for Infrastructure, School head, physical facilities coordinator, school inspectorate committee and members of PTA/SGC are authorized to monitor the project;
- Removed/Salvaged/Replaced materials should remain as property of the school/PE;
- Contractors to be in charge in securing the materials delivered in the school/PE;
- Project engineer to update the school/procuring entity on the progress of the project (2x a month) using the template to be provided before the start of the project;
- Contractor to bring own water tank (plus water delivery);
- Contractor to install sub meter for (for electricity consumption);
- Workers to have IDs and if possible, uniforms for easy identification and to prevent unauthorized persons entering the school/PE premises specially at night;
- Allot at least 15 minutes for cleaning before the end of working hours to ensure the safety of the learners and the teachers (areas accessed by employees affected by the work);
- Strictly no smoking, momma and alcoholic drinks inside the PE premises and work site;
- No workers are allowed to work under the influence of liquor;
- Barracks is strictly for authorized workers only (no family members allowed to stay overnight);
- Observance of the “NO CONTACT POLICY” with the learners;
- Installation of blue canvass, yellow lines and other warning device/signs and perimeter fence where necessary to keep children/employees away from site hazards;
- Site clearing before turnover;
- Contractors are responsible in overseeing the health conditions of the workers and who must always be fit to work;
- Observe the minimum health protocols.



Republic of the Philippines
Department of Education
Cordillera Administrative Region
SCHOOLS DIVISION OF BAGUIO CITY

Request and Reminders to Bidders

1. Bidders may coordinate with the end user through Engr. Jordan Gas-ib, Division Engineer DepED SDO Baguio City with contact no. 09275849021 for site inspection.
2. All representatives of interested bidders (sole proprietorship, partnership, or corporation) are requested to submit an authorization from proprietor, general manager or the board of directors.
3. Those who bought bid documents are requested to notify the BAC through writing if they decide not to participate in the opening of bids.
4. If no on -going projects, submit a document stating “**NO ON GOING PROJECT**” signed by the authorized representative.
5. Bidders are not to modify any of the items provided in the Program of Works Detailed Cost Estimates. **Modification of any item will be outright disqualified.**
6. Bidders are requested to submit Soft copy stored in a flash drive of the duly priced Bill of Quantities and Program of Works using Microsoft Excel.
7. Bidders are requested to submit additional copy of bid docs (technical and financial), to be marked as “Copy 1”.
8. The Bidder is responsible to double check the full description of above requirements in the bidding documents issued by the Procuring Entity.
9. The bidders are requested to provide a Table of Contents and corresponding tab/label for each submitted technical and financial components to help ensure completeness of submission by the bidders and facilitate examination by the BAC.

Section VII. Drawings

Annex “A”

Section VIII. Bill of Quantities

Notes on the Bill of Quantities

Objectives

The objectives of the Bill of Quantities are:

- a. to provide sufficient information on the quantities of Works to be performed to enable Bids to be prepared efficiently and accurately; and
- b. when a Contract has been entered into, to provide a priced Bill of Quantities for use in the periodic valuation of Works executed.

In order to attain these objectives, Works should be itemized in the Bill of Quantities in sufficient detail to distinguish between the different classes of Works, or between Works of the same nature carried out in different locations or in other circumstances which may give rise to different considerations of cost. Consistent with these requirements, the layout and content of the Bill of Quantities should be as simple and brief as possible.

Daywork Schedule

A Daywork Schedule should be included only if the probability of unforeseen work, outside the items included in the Bill of Quantities, is high. To facilitate checking by the Entity of the realism of rates quoted by the Bidders, the Daywork Schedule should normally comprise the following:

- a. A list of the various classes of labor, materials, and Constructional Plant for which basic daywork rates or prices are to be inserted by the Bidder, together with a statement of the conditions under which the Contractor will be paid for work executed on a daywork basis.
- b. Nominal quantities for each item of Daywork, to be priced by each Bidder at Daywork rates as Bid. The rate to be entered by the Bidder against each basic Daywork item should include the Contractor's profit, overheads, supervision, and other charges.

Provisional Sums

A general provision for physical contingencies (quantity overruns) may be made by including a provisional sum in the Summary Bill of Quantities. Similarly, a contingency allowance for possible price increases should be provided as a provisional sum in the Summary Bill of Quantities. The inclusion of such provisional sums often facilitates budgetary approval by avoiding the need to request periodic supplementary approvals as the future need arises. Where such provisional sums or contingency allowances are used, the SCC should state the manner in which they will be used, and under whose authority (usually the Procuring Entity's Representative's).

The estimated cost of specialized work to be carried out, or of special goods to be supplied, by other contractors should be indicated in the relevant part of the Bill of Quantities as a particular provisional sum with an appropriate brief description. A separate procurement procedure is normally carried out by the Procuring Entity to select such specialized contractors. To provide an element of competition among the Bidders in respect of any facilities, amenities, attendance, etc., to be provided by the successful Bidder as prime Contractor for the use and convenience of the specialist contractors, each related provisional sum should be followed by an item in the Bill of Quantities inviting the Bidder to quote a sum for such amenities, facilities, attendance, etc.

Signature Box

A signature box shall be added at the bottom of each page of the Bill of Quantities where the authorized representative of the Bidder shall affix his signature. Failure of the authorized representative to sign each and every page of the Bill of Quantities shall be a cause for rejection of his bid.

These Notes for Preparing a Bill of Quantities are intended only as information for the Procuring Entity or the person drafting the Bidding Documents. They should not be included in the final documents.

Annex “B”

Section IX. Checklist of Technical and Financial Documents

Notes on the Checklist of Technical and Financial Documents

The prescribed documents in the checklist are mandatory to be submitted in the Bid, but shall be subject to the following:

- a. GPPB Resolution No. 09-2020 on the efficient procurement measures during a State of Calamity or other similar issuances that shall allow the use of alternate documents in lieu of the mandated requirements; or
- b. any subsequent GPPB issuances adjusting the documentary requirements after the effectivity of the adoption of the PBDs.

The BAC shall be checking the submitted documents of each Bidder against this checklist to ascertain if they are all present, using a non-discretionary “pass/fail” criterion pursuant to Section 30 of the 2016 revised IRR of RA No. 9184.

Checklist of Technical and Financial Documents

I. TECHNICAL COMPONENT ENVELOPE

Class "A" Documents

Legal Documents

- (a) Valid PhilGEPS Registration Certificate (Platinum Membership) (all pages);
or
- (b) Registration certificate from Securities and Exchange Commission (SEC), Department of Trade and Industry (DTI) for sole proprietorship, or Cooperative Development Authority (CDA) for cooperatives or its equivalent document;
and
- (c) Mayor's or Business permit issued by the city or municipality where the principal place of business of the prospective bidder is located, or the equivalent document for Exclusive Economic Zones or Areas;
and
- (e) Tax clearance per E.O. No. 398, s. 2005, as finally reviewed and approved by the Bureau of Internal Revenue (BIR).

Technical Documents

- (f) Statement of the prospective bidder of all its ongoing government and private contracts, including contracts awarded but not yet started, if any, whether similar or not similar in nature and complexity to the contract to be bid; include Goods and Infra**and**
- (g) Statement of the bidder's Single Largest Completed Contract (SLCC) similar to the contract to be bid, except under conditions provided under the rules; **and**
and Special PCAB License in case of Joint Ventures;
and registration for the type and cost of the contract to be bid; **and**
- (h) Original copy of Bid Security. If in the form of a Surety Bond, submit also a certification issued by the Insurance Commission;
or
Original copy of Notarized Bid Securing Declaration; **and**
- (i) Project Requirements, which shall include the following:
 - a. Organizational chart for the contract to be bid;
 - b. List of contractor's key personnel (*e.g.*, Project Manager, Project Engineers, Materials Engineers, and Foremen), to be assigned to the contract to be bid, with their complete qualification and experience data;
 - c. List of contractor's major equipment units, which are owned, leased, and/or under purchase agreements, supported by proof of ownership or certification of availability of equipment from the equipment lessor/vendor for the duration of the project, as the case may be; **and**
- (j) Original duly signed Omnibus Sworn Statement (OSS);
and if applicable, Original Notarized Secretary's Certificate in case of a corporation, partnership, or cooperative; or Original Special Power of Attorney of all members of the joint venture giving full power and authority to its officer to sign the OSS and do acts to represent the Bidder.

Financial Documents

- (k) The prospective bidder's audited financial statements, showing, among others, the prospective bidder's total and current assets and liabilities, stamped "received" by the BIR or its duly accredited and authorized institutions, for the preceding calendar year which should not be earlier than two (2) years from the date of bid submission; **and**
- (l) The prospective bidder's computation of Net Financial Contracting Capacity (NFCC).

Class "B" Documents

- (m) If applicable, duly signed joint venture agreement (JVA) in accordance with RA No. 4566 and its IRR in case the joint venture is already in existence;
or
duly notarized statements from all the potential joint venture partners stating that they will enter into and abide by the provisions of the JVA in the instance that the bid is successful.

II. FINANCIAL COMPONENT ENVELOPE

- (n) Original of duly signed and accomplished Financial Bid Form; **and**

Other documentary requirements under RA No. 9184

- (o) Original of duly signed Bid Prices in the Bill of Quantities; **and**
 (p) Duly accomplished Detailed Estimates Form, including a summary sheet indicating the unit prices of construction materials, labor rates, and equipment rentals used in coming up with the Bid; **and**
 (q) Cash Flow by Quarter.

Bid Securing Declaration Form

[shall be submitted with the Bid if bidder opts to provide this form of bid security]

REPUBLIC OF THE PHILIPPINES)

CITY OF _____) S.S.

BID SECURING DECLARATION

Project Identification No.: *[Insert number]*

To: *[Insert name and address of the Procuring Entity]*

I/We, the undersigned, declare that:

1. I/We understand that, according to your conditions, bids must be supported by a Bid Security, which may be in the form of a Bid Securing Declaration.
2. I/We accept that: (a) I/we will be automatically disqualified from bidding for any procurement contract with any procuring entity for a period of two (2) years upon receipt of your Blacklisting Order; and, (b) I/we will pay the applicable fine provided under Section 6 of the Guidelines on the Use of Bid Securing Declaration, within fifteen (15) days from receipt of the written demand by the procuring entity for the commission of acts resulting to the enforcement of the bid securing declaration under Sections 23.1(b), 34.2, 40.1 and 69.1, except 69.1(f), of the IRR of RA No. 9184; without prejudice to other legal action the government may undertake.
3. I/We understand that this Bid Securing Declaration shall cease to be valid on the following circumstances:
 - . Upon expiration of the bid validity period, or any extension thereof pursuant to your request;
 - . I am/we are declared ineligible or post-disqualified upon receipt of your notice to such effect, and (i) I/we failed to timely file a request for reconsideration or (ii) I/we filed a waiver to avail of said right; and
 - . I am/we are declared the bidder with the Lowest Calculated Responsive Bid, and I/we have furnished the performance security and signed the Contract.

IN WITNESS WHEREOF, I/We have hereunto set my/our hand/s this ____ day of [month]
[year] at [place of execution].

—

*[Insert NAME OF BIDDER OR ITS AUTHORIZED
REPRESENTATIVE]*

[Insert signatory's legal capacity]

Affiant

[Jurat]

[Format shall be based on the latest Rules on Notarial Practice]

Omnibus Sworn Statement (Revised)

[shall be submitted with the Bid]

REPUBLIC OF THE PHILIPPINES)

CITY/MUNICIPALITY OF _____) S.S.

AFFIDAVIT

I, [Name of Affiant], of legal age, [Civil Status], [Nationality], and residing at [Address of Affiant], after having been duly sworn in accordance with law, do hereby depose and state that:

1. *[Select one, delete the other:]*

[If a sole proprietorship:] I am the sole proprietor or authorized representative of [Name of Bidder] with office address at [address of Bidder];

[If a partnership, corporation, cooperative, or joint venture:] I am the duly authorized and designated representative of [Name of Bidder] with office address at [address of Bidder];

2. *[Select one, delete the other:]*

[If a sole proprietorship:] As the owner and sole proprietor, or authorized representative of [Name of Bidder], I have full power and authority to do, execute and perform any and all acts necessary to participate, submit the bid, and to sign and execute the ensuing contract for [Name of the Project] of the [Name of the Procuring Entity], as shown in the attached duly notarized Special Power of Attorney;

[If a partnership, corporation, cooperative, or joint venture:] I am granted full power and authority to do, execute and perform any and all acts necessary to participate, submit the bid, and to sign and execute the ensuing contract for [Name of the Project] of the [Name of the Procuring Entity], as shown in the attached [state title of attached document showing proof of authorization (e.g., duly notarized Secretary’s Certificate, Board/Partnership Resolution, or Special Power of Attorney, whichever is applicable)];

3. [Name of Bidder] is not “blacklisted” or barred from bidding by the Government of the Philippines or any of its agencies, offices, corporations, or Local Government Units, foreign government/foreign or international financing institution whose blacklisting rules have been recognized by the Government Procurement Policy Board, **by itself or by relation, membership, association, affiliation, or controlling interest with another blacklisted person or entity as defined and provided for in the Uniform Guidelines on Blacklisting;**

4. Each of the documents submitted in satisfaction of the bidding requirements is an authentic copy of the original, complete, and all statements and information provided therein are true and correct;

5. [Name of Bidder] is authorizing the Head of the Procuring Entity or its duly authorized representative(s) to verify all the documents submitted;

6. *[Select one, delete the rest:]*

[If a sole proprietorship:] The owner or sole proprietor is not related to the Head of the Procuring Entity, members of the Bids and Awards Committee (BAC), the Technical Working Group, and the BAC Secretariat, the head of the Project Management Office or the end-user unit, and the project consultants by consanguinity or affinity up to the third civil degree;

[If a partnership or cooperative:] None of the officers and members of *[Name of Bidder]* is related to the Head of the Procuring Entity, members of the Bids and Awards Committee (BAC), the Technical Working Group, and the BAC Secretariat, the head of the Project Management Office or the end-user unit, and the project consultants by consanguinity or affinity up to the third civil degree;

[If a corporation or joint venture:] None of the officers, directors, and controlling stockholders of *[Name of Bidder]* is related to the Head of the Procuring Entity, members of the Bids and Awards Committee (BAC), the Technical Working Group, and the BAC Secretariat, the head of the Project Management Office or the end-user unit, and the project consultants by consanguinity or affinity up to the third civil degree;

7. *[Name of Bidder]* complies with existing labor laws and standards; and

8. *[Name of Bidder]* is aware of and has undertaken the responsibilities as a Bidder in compliance with the Philippine Bidding Documents, which includes:

- a. Carefully examining all of the Bidding Documents;
- b. Acknowledging all conditions, local or otherwise, affecting the implementation of the Contract;
- c. Making an estimate of the facilities available and needed for the contract to be bid, if any; and
- d. Inquiring or securing Supplemental/Bid Bulletin(s) issued for the *[Name of the Project]*.

9. *[Name of Bidder]* did not give or pay directly or indirectly, any commission, amount, fee, or any form of consideration, pecuniary or otherwise, to any person or official, personnel or representative of the government in relation to any procurement project or activity.

10. In case advance payment was made or given, failure to perform or deliver any of the obligations and undertakings in the contract shall be sufficient grounds to constitute criminal liability for Swindling (Estafa) or the commission of fraud with unfaithfulness or abuse of confidence through misappropriating or converting any payment received by a person or entity under an obligation involving the duty to deliver certain goods or services, to the prejudice of the public and the government of the Philippines pursuant to Article 315 of Act No. 3815 s. 1930, as amended, or the Revised Penal Code.

IN WITNESS WHEREOF, I have hereunto set my hand this ___ day of ___, 20__ at _____, Philippines.

[Insert NAME OF BIDDER OR ITS AUTHORIZED REPRESENTATIVE]

[Insert signatory's legal capacity]

Affiant

[Jurat]

[Format shall be based on the latest Rules on Notarial Practice]

Bid Form for the Procurement of Infrastructure Projects

[shall be submitted with the Bid]

BID FORM

Date : _____

Project Identification No. : _____

To: *[name and address of Procuring Entity]*

Having examined the Philippine Bidding Documents (PBDs) including the Supplemental or Bid Bulletin Numbers *[insert numbers]*, the receipt of which is hereby duly acknowledged, we, the undersigned, declare that:

- a. We have no reservation to the PBDs, including the Supplemental or Bid Bulletins, for the Procurement Project: *[insert name of contract]*;
- b. We offer to execute the Works for this Contract in accordance with the PBDs;
- c. The total price of our Bid in words and figures, excluding any discounts offered below is: *[insert information]*;
- d. The discounts offered and the methodology for their application are: *[insert information]*;
- e. The total bid price includes the cost of all taxes, such as, but not limited to: *[specify the applicable taxes, e.g. (i) value added tax (VAT), (ii) income tax, (iii) local taxes, and (iv) other fiscal levies and duties]*, which are itemized herein and reflected in the detailed estimates,
- f. Our Bid shall be valid within the a period stated in the PBDs, and it shall remain binding upon us at any time before the expiration of that period;
- g. If our Bid is accepted, we commit to obtain a Performance Security in the amount of *[insert percentage amount]* percent of the Contract Price for the due performance of the Contract, or a Performance Securing Declaration in lieu of the the allowable forms of Performance Security, subject to the terms and conditions of issued GPPB guidelines for this purpose;
- h. We are not participating, as Bidders, in more than one Bid in this bidding process, other than alternative offers in accordance with the Bidding Documents;

- i. We understand that this Bid, together with your written acceptance thereof included in your notification of award, shall constitute a binding contract between us, until a formal Contract is prepared and executed; and
- j. We understand that you are not bound to accept the Lowest Calculated Bid or any other Bid that you may receive.
- k. We likewise certify/confirm that the undersigned, is the duly authorized representative of the bidder, and granted full power and authority to do, execute and perform any and all acts necessary to participate, submit the bid, and to sign and execute the ensuing contract for the [Name of Project] of the [Name of the Procuring Entity].
- l. We acknowledge that failure to sign each and every page of this Bid Form, including the Bill of Quantities, shall be a ground for the rejection of our bid.

Name: _____

Legal Capacity: _____

Signature: _____

Duly authorized to sign the Bid for and behalf of _____

Date: _____

Contract ID:
Name of Project:
Location of Project:

STATEMENT OF SINGLE LARGEST COMPLETED CONTRACT SIMILAR TO THE CONTRACT TO BE BID

Business Name : _____
Business Address : _____

	Name of Contract/Location	a. Owner's Name b. Address c. Telephone No.	Nature of Work	Contractor's Role		a. Amount at Award b. Amount at Completion c. Duration	a. Date Awarded b. Date of Contract c. Date Completed
				Description <small>(Sole Contractor, Subcontractor, Partner in a JV)</small>	%		

Note:
This statement shall be supported with:

- 1. Notice of Award and/or Contract*
- 2. Notice to Proceed issued by the owner*
- 3. Certificate of Accomplishment signed by the owner or Project Engineer*

Submitted by : _____
(Printed Name and Signature)
Designation : _____
Date : _____

Contract ID:
 Name of Project:
 Location of
 Project:

LIST OF ALL ONGOING GOVERNMENT AND PRIVATE CONSTRUCTION CONTRACTS INCLUDING CONTRACTS AWARDED BUT NOT YET STARTED (ALL INFRASTRUCTURE)

Business Name : _____
 Business Address : _____

Name of Contract/Location	a. Owner's Name b. Address c. Telephone No.	Nature of Work	Contractor's Role		a. Contract Value at Award b. Date of Contract c. Contract Duration d. Date Started	% of Accomplishment		Value of Outstanding Works
			Description (Sole Contractor, Subcontractor, Partner in a JV)	%		Planned	Actual	

Note:
 This statement shall be supported with:
 1. Contract
 2. CPES rating sheets and/or Certificate of Completion
 3. Certificate of Acceptance

Submitted by : _____
 (Printed Name and Signature)
 Designation : _____
 Date : _____





Republic of the Philippines
Department of Education
Cordillera Administrative Region
SCHOOLS DIVISION OF BAGUIO CITY

Invitation to Bid for

***REPAIR OF CLASSROOMS AT DONA AURORA ELEMENTARY
SCHOOL***

Bid Reference No. 024, s.2024
Approved Budget for the Contract – ₱ 1,000,000.00

1. The *Department of Education, Schools Division of Baguio City*, through the *2024 Basic Educational Facilities Fund (2024 BEFF)* intends to apply the sum of *One million Pesos Only (₱ 1,000,000.00)* being the Approved Budget for the Contract (ABC) to payments under the contract for *Repair of Classrooms at Dona Aurora Elementary School*. Bids received in excess of the ABC shall be automatically rejected at bid opening.
2. The *Department of Education, Schools Division of Baguio City* now invites bids for the above Procurement Project. Completion of the Works is required *61 calendar days*. Bidders should have completed a contract similar to the Project. The description of an eligible bidder is contained in the Bidding Documents, particularly, in Section II (Instructions to Bidders).
3. Bidding will be conducted through open competitive bidding procedures using non-discretionary “*pass/fail*” criterion as specified in the 2016 revised Implementing Rules and Regulations (IRR) of Republic Act (RA) No. 9184.
4. Interested bidders may obtain further information from *Department of Education, Schools Division of Baguio City, #82 Military Cut-Off, Baguio City* and inspect the Bidding Documents at www.depedpines.com or the address given during *Monday to Friday from 8:00 AM - 5:00 PM*.
5. A complete set of Bidding Documents may be acquired by interested bidders from *October 1, 2024* on the given address and website/s below *and upon payment of the applicable fee for the Bidding Documents, pursuant to the latest Guidelines issued by the GPPB, in the amount of One Thousand Pesos Only (P 1,000.00)*. The Procuring Entity shall allow the bidder to present its proof of payment for the *fees personally or by electronic means through the agency’s Landbank Account with account no. 0222-0209-64 but must first acquire an order of payment from the agency through (074) 442-7819*.
6. The *Department of Education, Schools Division of Baguio City* will hold a Pre-Bid Conference¹ on *October 9, 2024, 10:00 AM* at *Department of Education, Schools Division of Baguio City Conference Hall, # 82 Military Cut-Off, Baguio City* and/or through videoconferencing/webcasting *via Zoom Video Conferencing through the link :<https://tinyurl.com/depedbaguiobac>*, which shall be open to prospective bidders.
7. Bids must be duly received by the BAC Secretariat through: (i) manual submission at the office address as indicated below, (ii) online or electronic submission as indicated below, or (iii) both on or before *October 21, 2024, 9:45 AM*. Late bids shall not be accepted.

¹ May be deleted in case the ABC is less than One Million Pesos (PhP1,000,000) where the Procuring Entity may not hold a pre-bid conference.

8. All bids must be accompanied by a bid security in any of the acceptable forms and in the amount stated in **ITB** Clause 16.
9. Bid opening shall be on **October 21, 2024, 10:00 AM** at *DepEd, Schools Division of Baguio City Conference Hall, # 82 Military Cut-Off, Baguio City* and/or through **Zoom Video Conferencing** through the link :<https://tinyurl.com/depedbagueiobac>. Bids will be opened in the presence of the bidders' representatives who choose to attend the activity.
10. *Bidders are advised to log in to the Zoom Video Conferencing through the link :<https://tinyurl.com/depedbagueiobac> and wait for further advice to join the BAC meeting.*
11. The **Department of Education, Schools Division of Baguio City** reserves the right to reject any and all bids, declare a failure of bidding, or not award the contract at any time prior to contract award in accordance with Sections 35.6 and 41 of the 2016 revised Implementing Rules and Regulations (IRR) of RA No. 9184, without thereby incurring any liability to the affected bidder or bidders.
12. For further information, please refer to:

CARMEL F. MERIS

BAC Chairperson

Department of Education, Schools Division of Baguio City

Address: # 82 Military Cut-Off, Baguio City

Email Add: depedbagueiocity@gmail.com

Telefax No.:(074) 442 – 7819

Website: www.depedpines.com

13. You may visit the following websites:

For downloading of Bidding Documents: www.depedpines.com

For online bid submission: depedbagueiocity@gmail.com

Cc: depedbagueiobac@gmail.com

September 30, 2024

CARMEL F. MERIS

BAC Chairperson

For the BAC Chairperson



NINO M. TIBANGAY

BAC Vice Chairperson



VICINITY MAP
SCALE NTS

APPROPRIATION: P 1,000,000.00
 AAE: P 1,000,000.00
 SOURCE OF FUND: REPAIR 2024
 PROJECT DURATION: 61 Calendar days

SCOPE OF WORKS :

ITEM NO.	DESCRIPTION	QUANTITY	UNIT
(1)	(2)	(3)	(4)
B. Other General Requirements			
SPL 1	Project Billboard	1.00	Each
C. Mobilization and Demobilization			
C.1	Mobilization and Demobilization	1.00	Ls
2.0000 Concreting Works (3000 psi)			
5 (f)	Chipping of Masonry Wall	5.26	sq m
Finishing Works			
5 (d)	Plain Cement Plaster Finish	16.43	sq.m
6.0000 Fabricated Materials and Hardware			
6 (b)	Removal of Window with Jamb	26.34	sq m
6 (h)	Analok frame window	30.24	sq.m
6 (i)	Window grills	28.80	sq.m
7.0000 Steel Works			
7 (j)	Metal Structure Fascia	67.00	l.m
8.0000 Roofing Works			
8 (f)	Removal of Gutter	41.00	l.m
8 (g)	Removal of Flashing	26.00	l.m
8 (d)	Fabricated Metal Roofing Accessory (Gutter)	41.00	l.m
8 (e)	Fabricated Metal Roofing Accessory (Ridge/ Hip Rolls/ Flashing/ Counter Flashing/ Valley Roll)	26.00	l.m
9.0000 Ceiling and Carpentry Works			
9 (j)	Removal of Soffit	74.11	sq m
9 (d)	Removal of Ceiling	33.84	sq m
9 (k)	Removal of Fascia	67.00	l.m
9 (l)	PVC panel on Metal Frame Ceiling	33.84	sq.m
9 (m)	Spandrel on Metal Frame Ceiling	74.11	sq.m
10.0000 Electrical Works			
10 (a)	Conduit, Boxes and Fitting	1.00	Ls
10 (b)	Wires and Wiring Devices	1.00	Ls
10 (c)	Lighting Fixture/ Fixture	1.00	Ls
11.0000 Plumbing Works			
11 (b)	Rainwater Downspout	1.00	Ls
13.0000 Painting Works			
13 (a)	Masonry Painting	299.65	sq.m
13 (c)	Metal Painting	260.65	sq.m

Minimum Required Equipment:

-Dump Truck (3 cu.m.)	-Welding Machine
-Jack Hammer Drill	-Electric Grinder
-Electric jackhammer	-G.I. pipe Scaffolds
-H - Frame 1.7m x 1.2m	

SUPERVISION REQ'T:
 a. 1 CONSTRUCTION FOREMAN
 b. 1 CIVIL ENGINEER

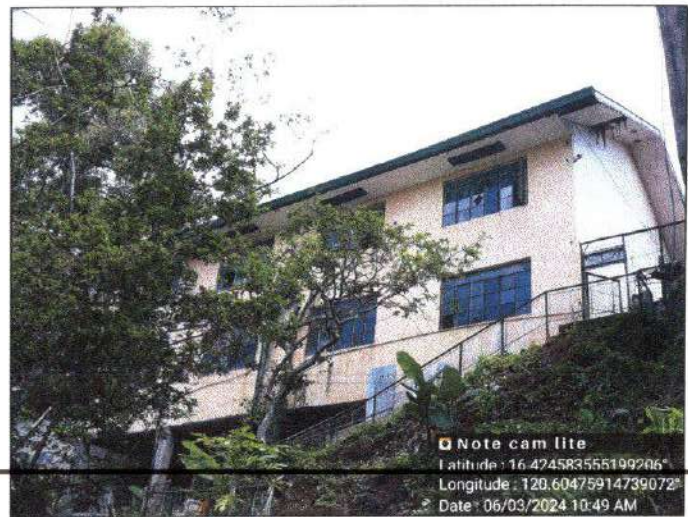
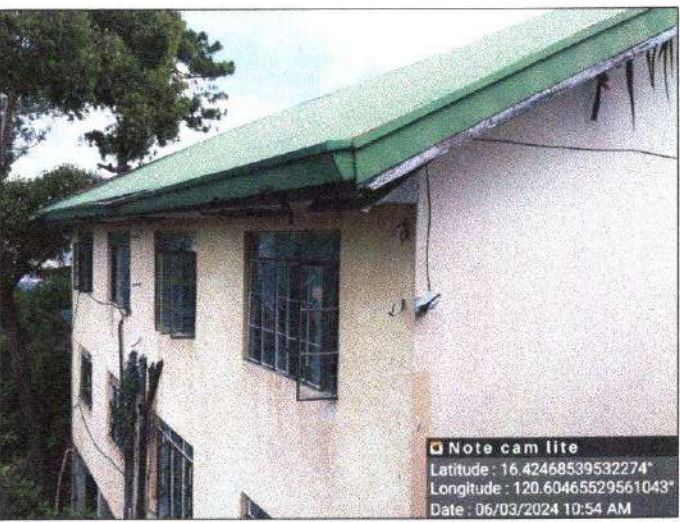

ACTUAL SITE CONDITION
SCALE NTS

<p>DepEd SCHOOLS DIVISION OFFICE</p> <p>#82 MILITARY CUTOFF RD. BAGUIO CITY</p>	PROJECT TITLE & LOCATION: <p align="center">REPAIR OF CLASSROOMS AT DOÑA AURORA ELEMENTARY SCHOOL</p> <p align="center">NORTH CENTRAL AURORA HILL, BAGUIO CITY</p>	PREPARED BY: <p align="center"><i>Jordan B. Gas</i> JORDAN B. GAS - IB ENGINEER III</p> DATE:	RECOMMENDING APPROVAL: <p align="center"><i>Niño M. Tibangay</i> NIÑO M. TIBANGAY CHIEF, SGOD</p> DATE:	APPROVED: <p align="center"><i>Soraya T. Paculo</i> SORAYA T. PACULO PhD, CESO VI DIC-SCHOOLS DIVISION SUPERINTENDENT</p> DATE:	SHEET CONTENTS: -AS SHOWN	SHEET NO: <p align="center">1 5</p>
	PROJECT TITLE & LOCATION: <p align="center">REPAIR OF CLASSROOMS AT DOÑA AURORA ELEMENTARY SCHOOL</p> <p align="center">NORTH CENTRAL AURORA HILL, BAGUIO CITY</p>		PREPARED BY: <p align="center"><i>Jordan B. Gas</i> JORDAN B. GAS - IB ENGINEER III</p> DATE:	RECOMMENDING APPROVAL: <p align="center"><i>Niño M. Tibangay</i> NIÑO M. TIBANGAY CHIEF, SGOD</p> DATE:	APPROVED: <p align="center"><i>Soraya T. Paculo</i> SORAYA T. PACULO PhD, CESO VI DIC-SCHOOLS DIVISION SUPERINTENDENT</p> DATE:	SHEET CONTENTS: -AS SHOWN

SPECIFICATIONS:

PRACTICE GOOD HIGH QUALITY WORKMANSHIP.

USE GOOD QUALITY OF CONSTRUCTION MATERIALS.

6.0000. FABRICATED MATERIALS AND HARDWARE

- 6 (i) Window grills:
 -Flat bar, 37.5x4.47mm
 -Angle bar, 37.5x37.5x4.47mm
 -Epoxy Primer Gray (2 coats)
 -Epoxy Enamel (2 coats)

7.0000. STEEL WORKS

- 7 (j) Metal structure fascia:
 -C purlins, 1.5mmx2"x10"
 -Epoxy Primer Gray (2 coats)

8.0000. ROOFING WORKS

- 8 (d) Fabricated Metal Roofing Accessory (Gutter):
 -G.I. Flashing, Preformed, Pre-Painted, 0.610m x 2.440m x 0.6mm BMT
- 8 (e) Fabricated Metal Roofing Accessory (Ridge/ Hip Rolls/ Flashing/ Counter Flashing/ Valley Roll):
 -G.I. Flashing, Preformed, Pre-Painted, 0.610m x 2.440m x 0.5mm BMT

9.0000. CEILING AND CARPENTRY WORKS

- 9 (l) PVC panel on Metal Frame Ceiling:
 -Metal Carrying Channel (12mm x 38mm x 5m x 0.8mm thk)
 -Metal Double Furring Channel (19mm x 50mm x 3m x 0.5mm thk)
 -Wall Angle 1" x 1" x 10'

- 9 (m) Spandrel on Metal Frame Ceiling:
 -C purlins, 1.5mmx2"x4"
 -Spandrel with ventilation, 0.4mm, 110mmx1m
 -use Spandrel molding
 -use Fascia cover

10.0000. ELECTRICAL WORKS

- 10 (a) Conduit, Boxes and Fitting:
 -Electrical Conduit uPVC, 15mmØ
 -Electrical PVC moulding, 3/4" x 10'
- 10 (b) Wires and Wiring Devices:
 -2.0 mm² THHN Wire, Stranded
- 10 (c) Lighting Fixture/ Fixture:
 -LED Round light, 18w
 -Switch, wide, 3gang
 -Solar floodlight, 200w

11.0000. PLUMBING WORKS

- 11 (b) Rainwater Downspout:
 -PVC Sanitary Pipe 3"Ø x 3.0m, S-1000

13.0000. PAINTING WORKS

- 13 (a) Masonry Painting:
 -Latex, Flat (primer)
 -Masonry Putty
 -Latex, Semi Gloss (Deped colors, 2 coats)
- 13 (c) Metal Painting:
 -Roof Sealant (elastomeric)
 -Epoxy Primer Gray
 -Epoxy Enamel (Deped colors, 2 coats)

GENERAL NOTES:

- APPLY SAFETY PRACTICE THROUGHOUT CONSTRUCTION
- ALWAYS WEAR PPE WHEN ON JOBSITE
- ADJUSTMENTS MAY BE DONE AT JOBSITE TO SUIT ACTUAL FIELD CONDITION DURING CONSTRUCTION, UPON TO THE APPROVAL OF AREA ENGINEER
- SITE MUST BE FREE FROM EXCESS AND WASTE MATERIALS BEFORE FINAL INSPECTION OF THE COMPLETED PROJECT
- ALWAYS FOLLOW SITE INSTRUCTIONS
- INSTALL TARPAULIN AS PER COA CIRCULAR # 2013-2014 DATED JANUARY 30, 2013
- NO ACTIVITIES SHALL COMMENCE WITHOUT PRIOR PRE-CONSTRUCTION MEETING BETWEEN THE CONTRACTOR, THE PROJECT ENGINEER/ DESIGNER, AND THE SCHOOL HEAD/ PRINCIPAL OTHERWISE, ERROR/S ON THE LAYOUT WITHOUT THE CONDUCT OF THE AFOREMENTIONED PRE-CONSTRUCTION MEETING IS/ ARE SUBJECT TO REMOVAL OR REPEAT WITH THE CONTRACTOR'S EXPENSE.

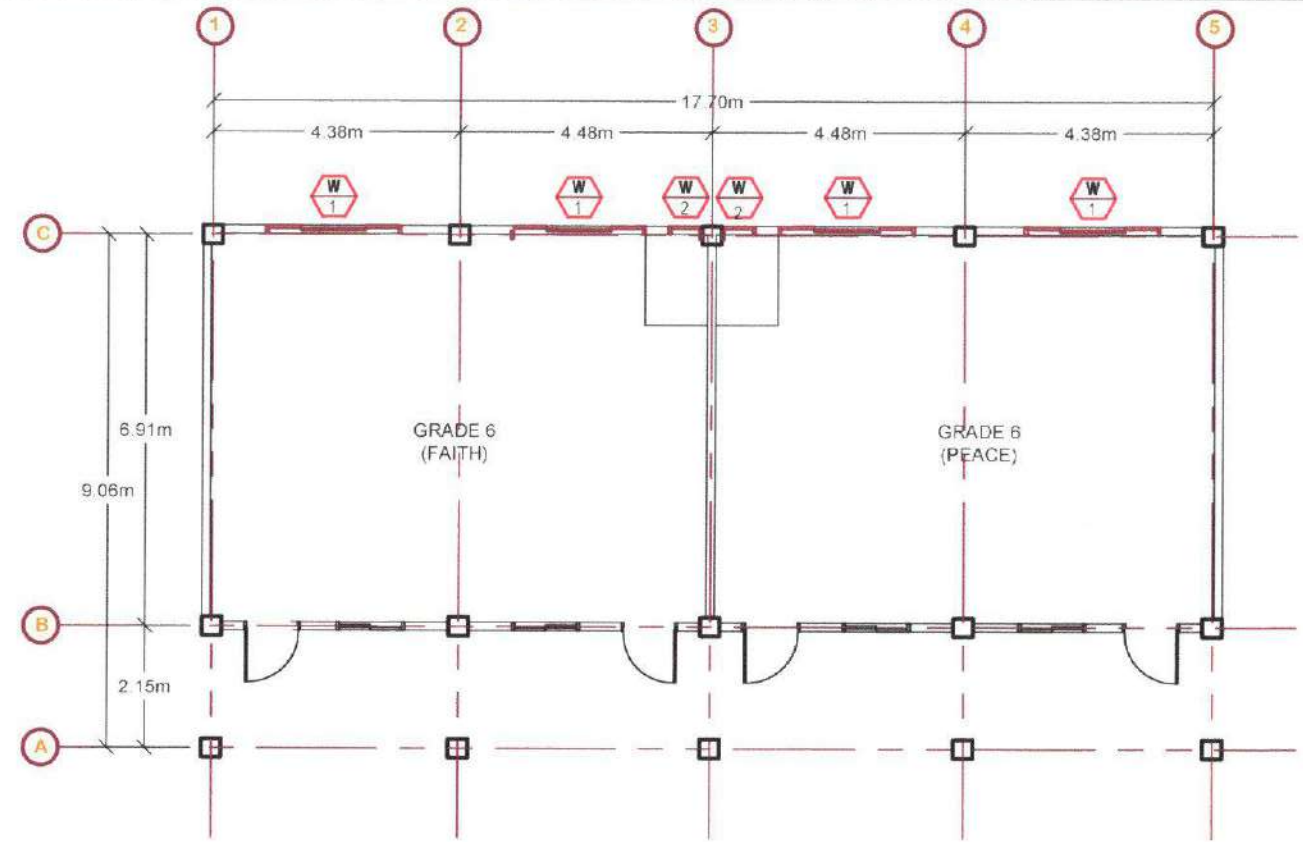

FIRST FLOOR PLAN
SCALE 1:133

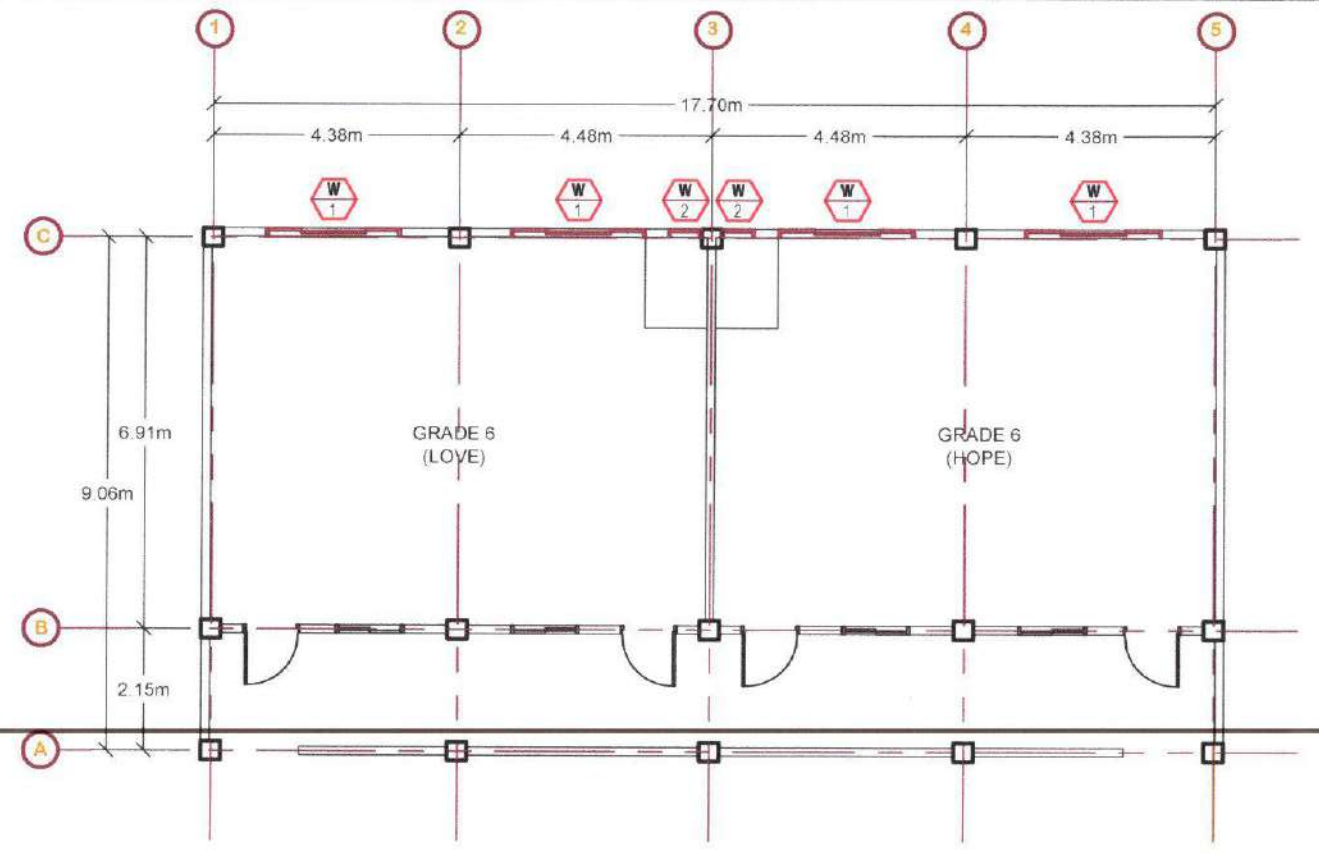

SECOND FLOOR PLAN
SCALE 1:133

<p>DepEd SCHOOLS DIVISION OFFICE</p> <p>#82 MILITARY CUTOFF RD. BAGUIO CITY</p>	<p>PROJECT TITLE & LOCATION:</p> <p>REPAIR OF CLASSROOMS AT DOÑA AURORA ELEMENTARY SCHOOL</p>	<p>PREPARED BY:</p> <p><i>Jordan B. Gas</i> JORDAN B. GAS - IB ENGINEER III</p>	<p>RECOMMENDING APPROVAL:</p> <p><i>Niño M. Tibangay</i> NIÑO M. TIBANGAY CHIEF, SGOD</p>	<p>APPROVED:</p> <p><i>Soraya T. Faculo</i> SORAYA T. FACULO PhD, CESO VI DIC-SCHOOLS DIVISION SUPERINTENDENT</p>	<p>SHEET CONTENTS:</p> <p>-AS SHOWN</p>	<p>SHEET NO.:</p> <p>2 5</p>
	<p>NORTH CENTRAL AURORA HILL, BAGUIO CITY</p>	<p>DATE</p>	<p>DATE</p>	<p>DATE</p>	<p>DATE</p>	

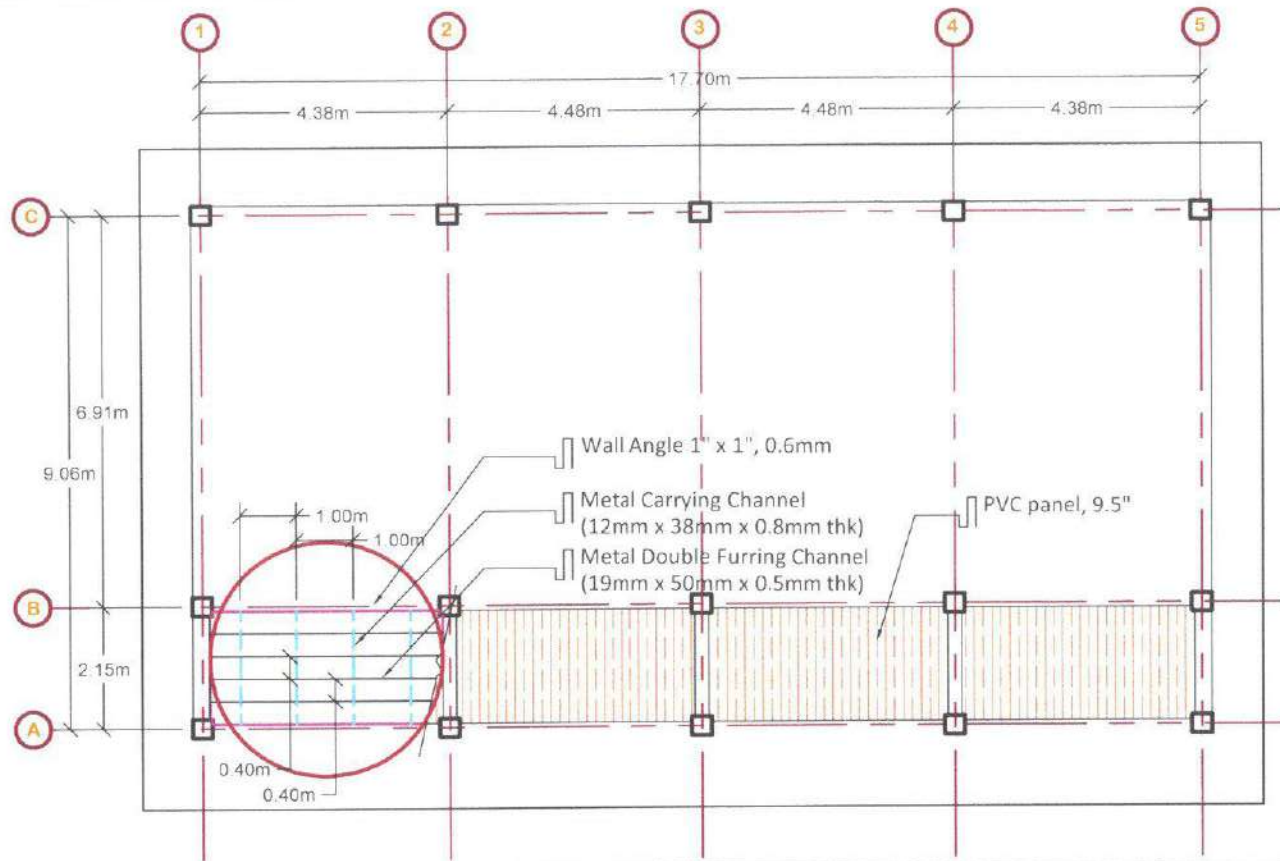

SECOND FLR CEILING AT HALLWAY PLAN
SCALE 1 : 1 3 3

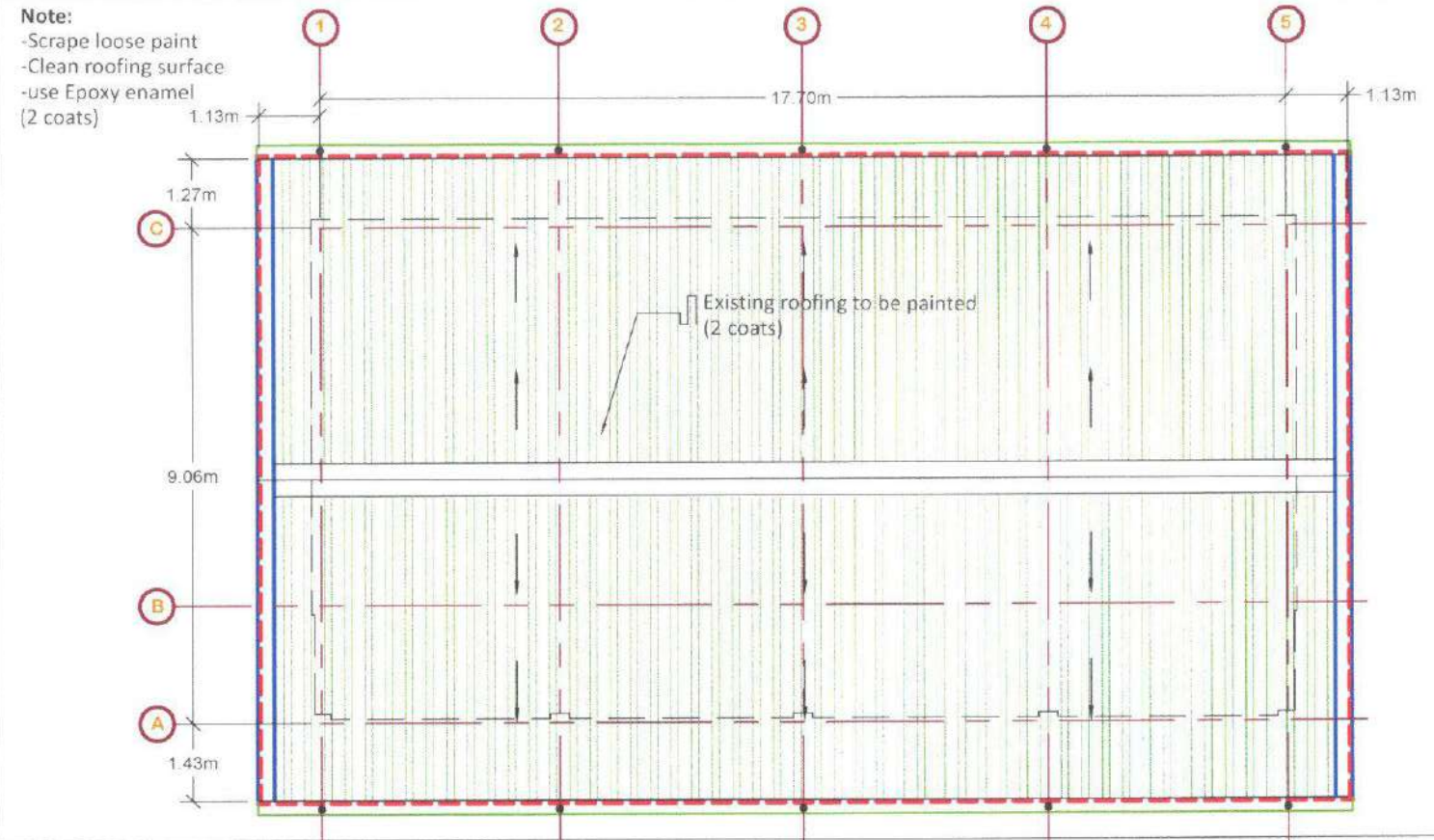

ROOF PLAN
SCALE 1 : 1 3 3

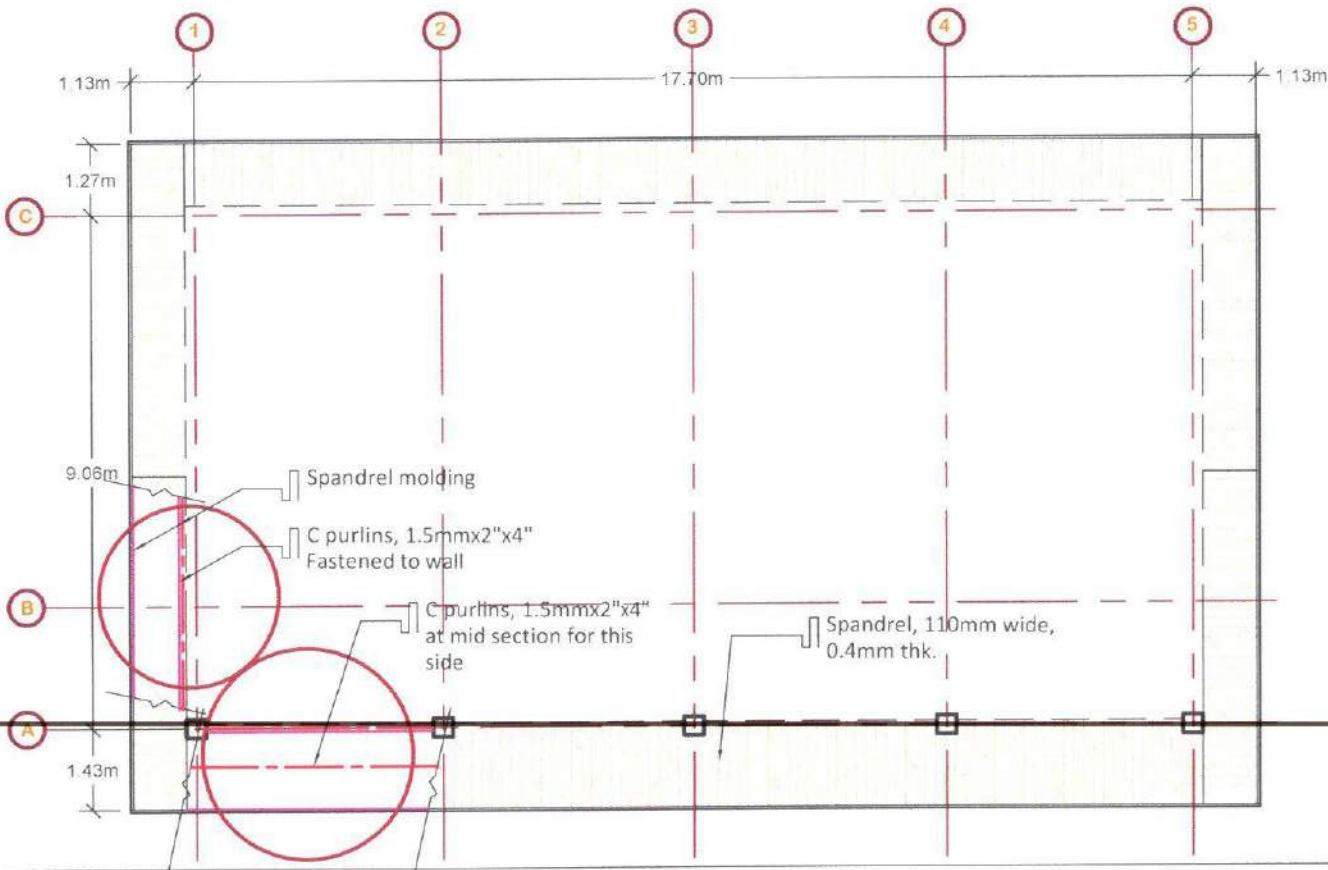

SECOND FLR EAVES/ SOFFIT PLAN
SCALE 1 : 1 3 3

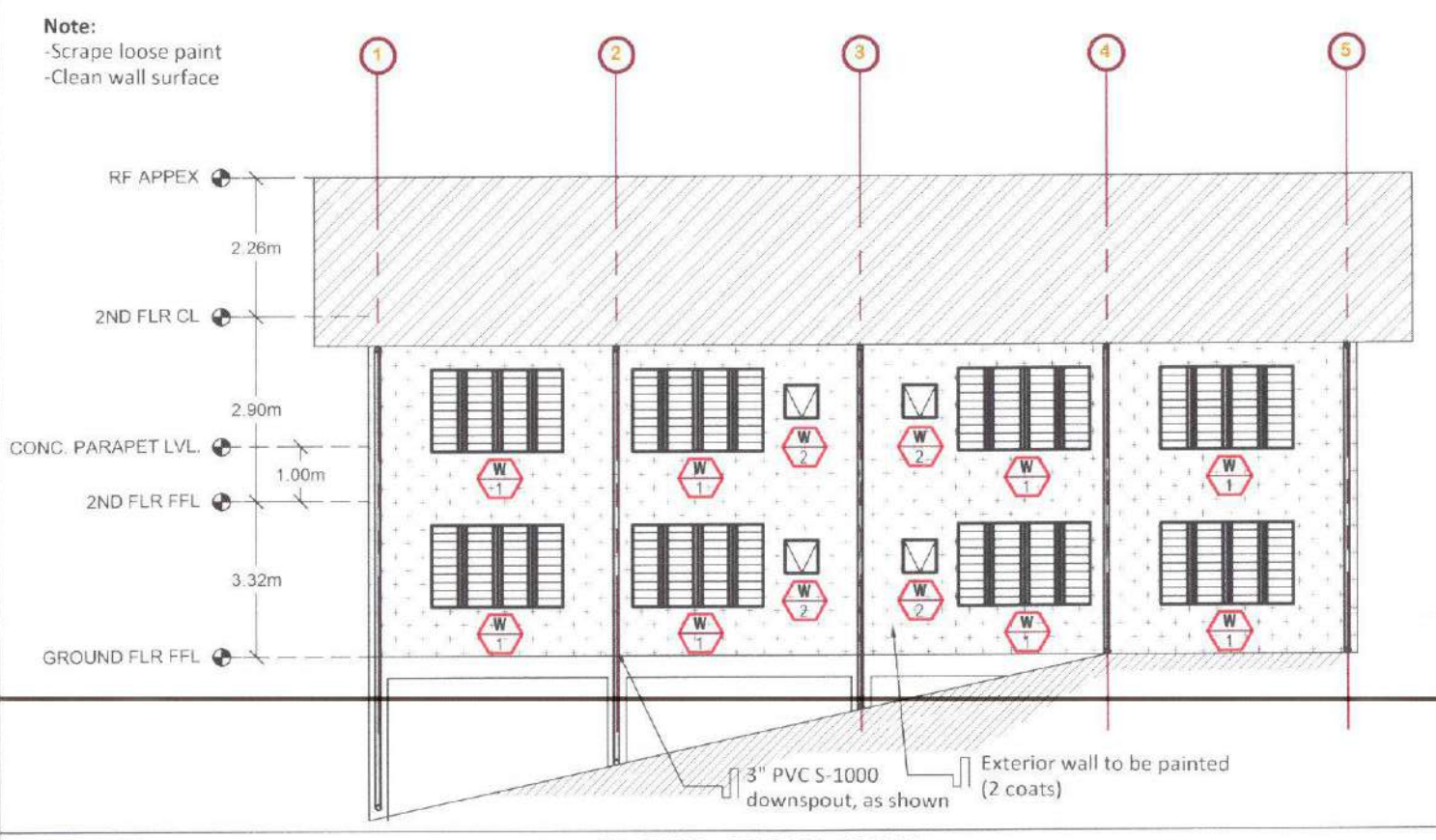

FRONT ELEVATION
SCALE 1 : 1 3 3

<p>DepEd SCHOOLS DIVISION OFFICE</p> <p>#82 MILITARY CUTOFF RD. BAGUIO CITY</p>	<p>PROJECT TITLE & LOCATION</p> <p>REPAIR OF CLASSROOMS AT DOÑA AURORA ELEMENTARY SCHOOL</p> <p>NORTH CENTRAL AURORA HILL, BAGUIO CITY</p>	<p>PREPARED BY</p> <p><i>Jordan B. Gas</i> JORDAN B. GAS - IB ENGINEER III</p> <p>DATE:</p>	<p>RECOMMENDING APPROVAL</p> <p><i>Nino M. Tibangay</i> NIÑO M. TIBANGAY CHIEF, SGOD</p> <p>DATE:</p>	<p>APPROVED:</p> <p><i>Soraya T. Faculo</i> SORAYA T. FACULO PhD, CESO VI DIC-SCHOOLS DIVISION SUPERINTENDENT</p> <p>DATE:</p>	<p>SHEET CONTENTS:</p> <p>-AS SHOWN</p>	<p>SHEET NO:</p> <p>3 5</p>
	<p>DepEd Schools Division Office - Baguio City</p>					

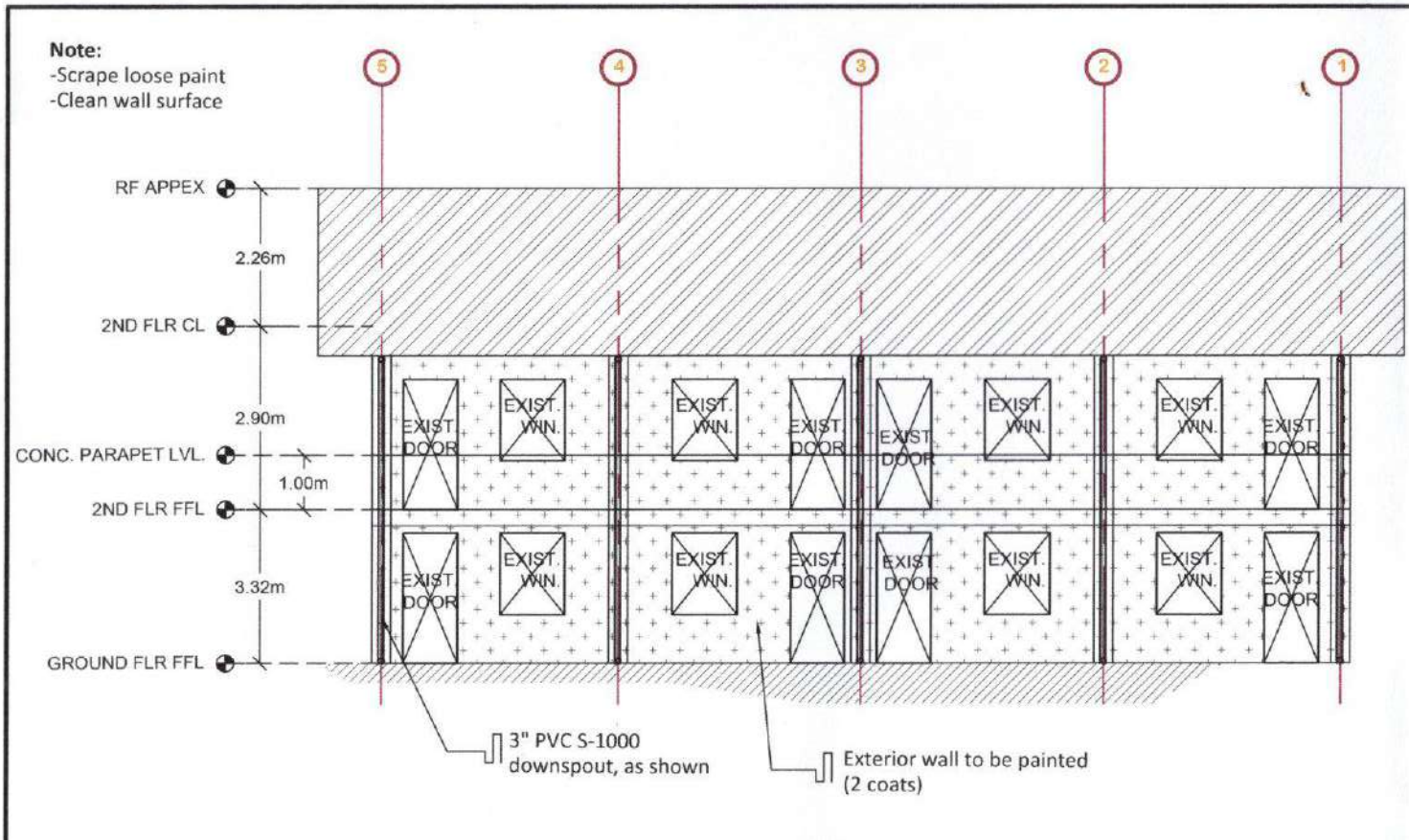

FRONT ELEVATION
SCALE 1:133

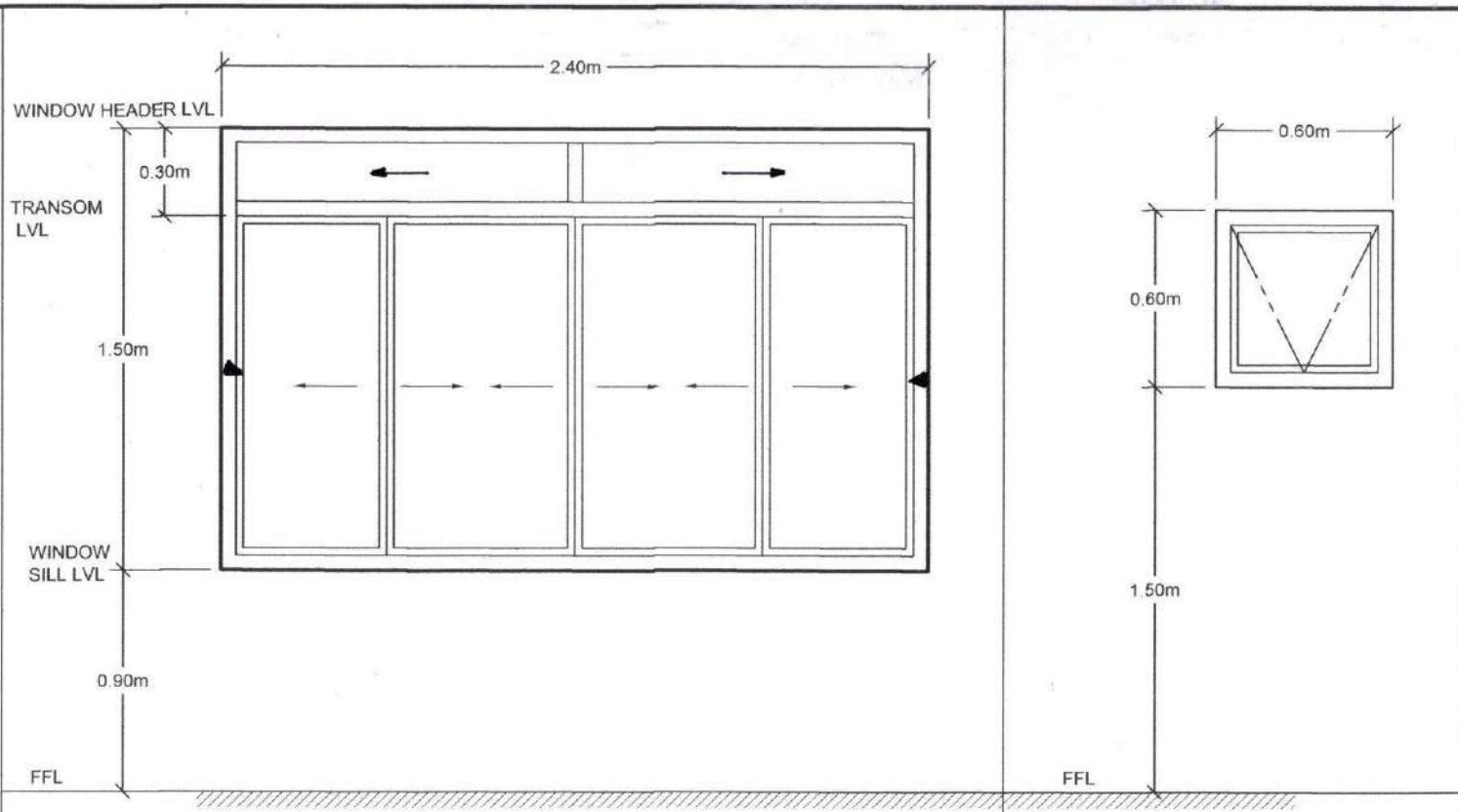

DESIGNATION:	W1	DESIGNATION:	W2
QTY:	8	QTY:	4
LOCATION:	CLASSROOM AT 1ST FLR AND 2ND FLR	LOCATION:	COMFORT ROOM
DESCRIPTION:	HIGH QUALITY ANALOK SLIDING WINDOW WITH 4.5mm CLEAR GLASS (W/ SECONDARY HOOK)	DESCRIPTION:	HIGH QUALITY ANALOK AWNING WINDOW WITH 4.5mm REFLECTIVE GLASS (W/ SECONDARY HOOK)

WINDOW SCHEDULE
SCALE 1:25

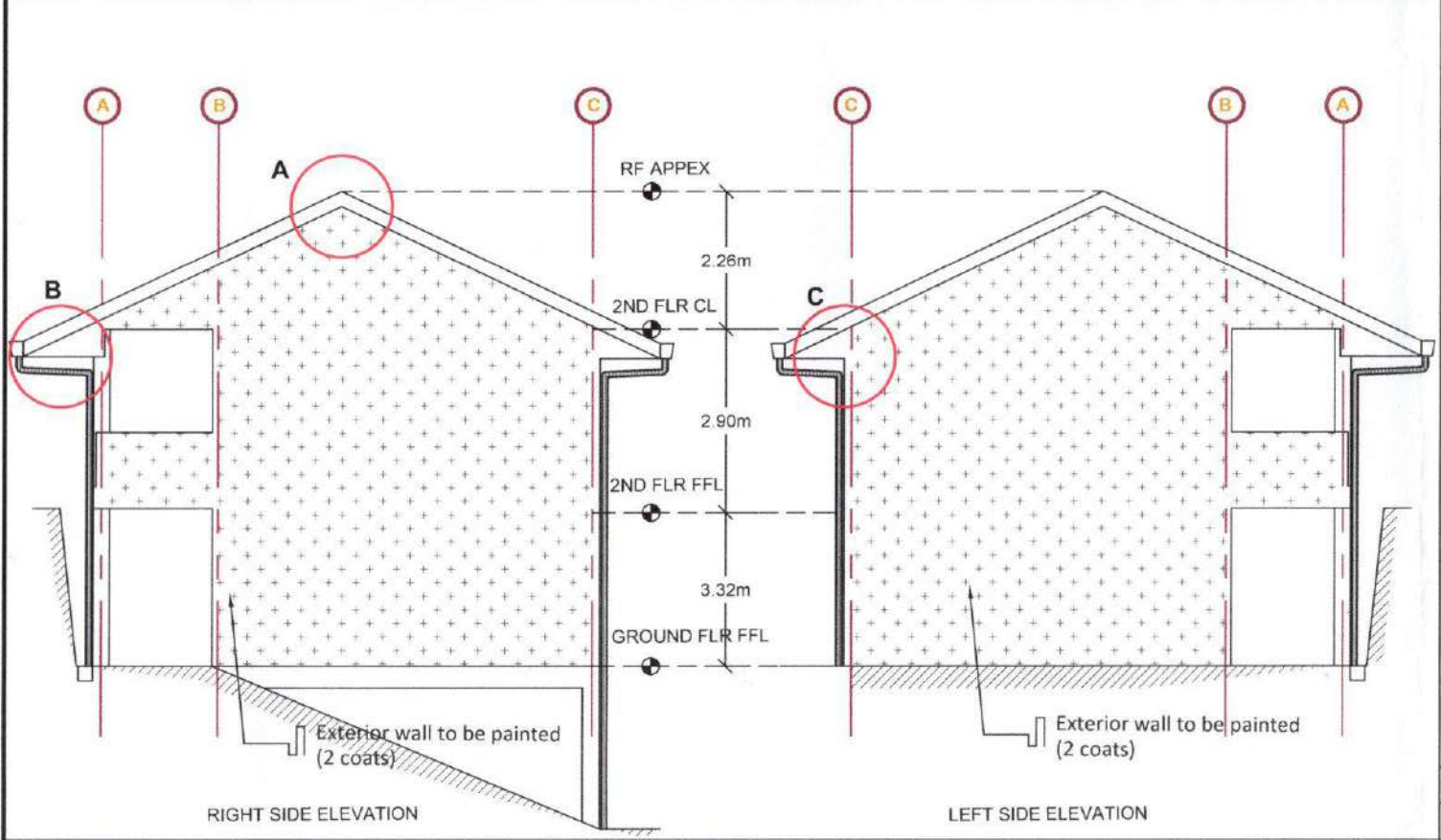

SIDE ELEVATION
SCALE 1:133

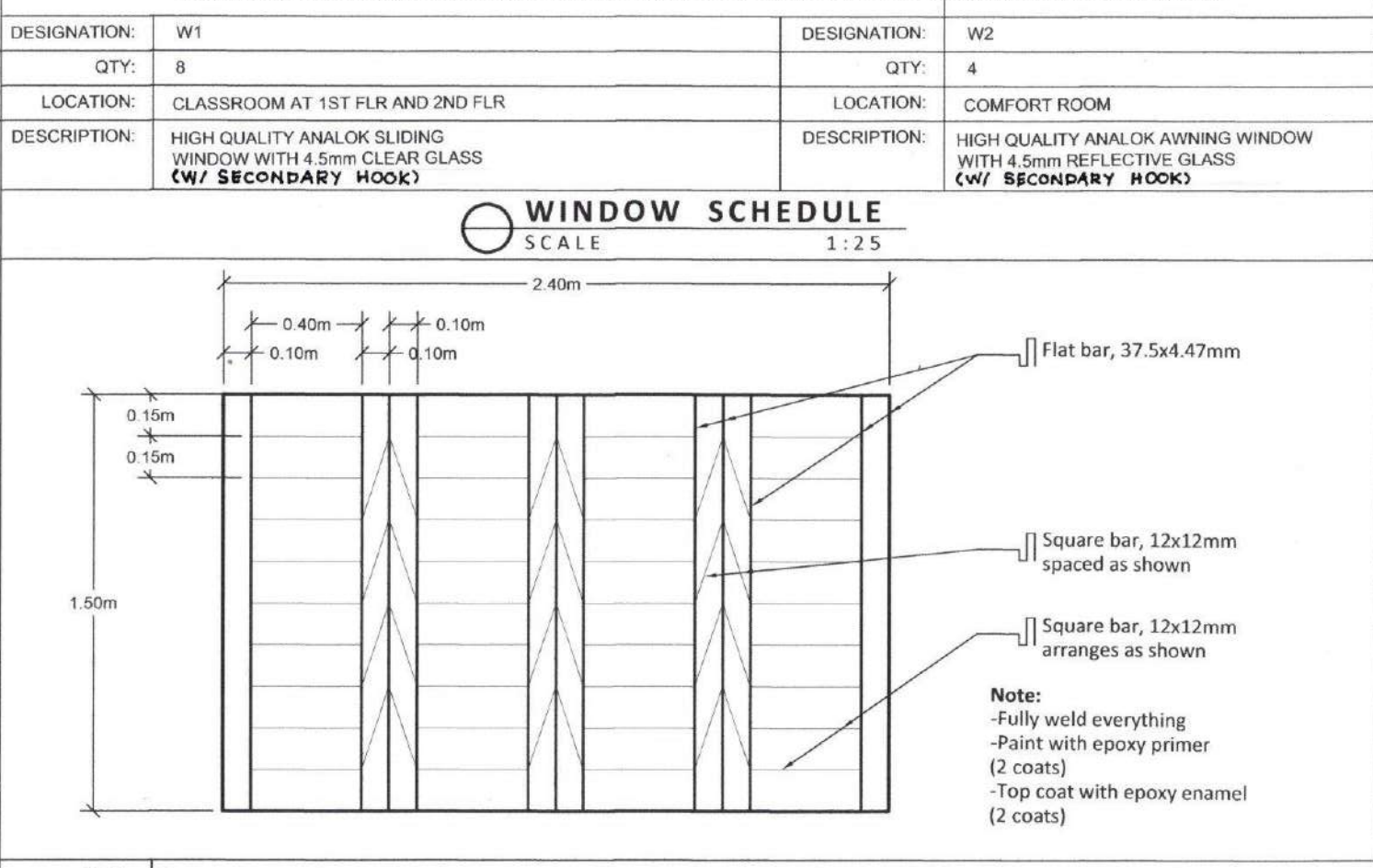

QTY:	8
LOCATION:	CLASSROOM AT 1ST FLR AND 2ND FLR (OUTSIDE)

WINDOW GRILL DETAIL
SCALE 1:25

<p>DepEd SCHOOLS DIVISION OFFICE #82 MILITARY CUTOFF RD, BAGUIO CITY</p>	<p>PROJECT TITLE & LOCATION: REPAIR OF CLASSROOMS AT DOÑA AURORA ELEMENTARY SCHOOL NORTH CENTRAL AURORA HILL, BAGUIO CITY</p>	<p>PREPARED BY: <i>Jordan B. Gas</i> JORDAN B. GAS - IB ENGINEER III DATE:</p>	<p>RECOMMENDING APPROVAL: <i>Niño M. Tibangay</i> NIÑO M. TIBANGAY CHIEF, SGOD DATE:</p>	<p>APPROVED: <i>Soraya T. Faculo</i> SORAYA T. FACULO PhD, CESO VI OIC-SCHOOLS DIVISION SUPERINTENDENT DATE:</p>	<p>SHEET CONTENTS: -AS SHOWN</p>	<p>SHEET NO. 4 5</p>

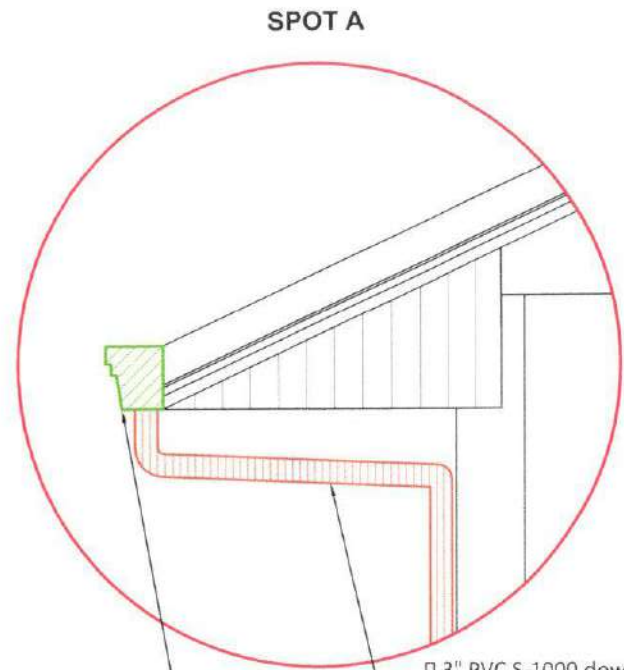

Note:
 -Provide ventilation/ Use Spandrel with vent
 -Seal everything (gap, connection, rivet head)

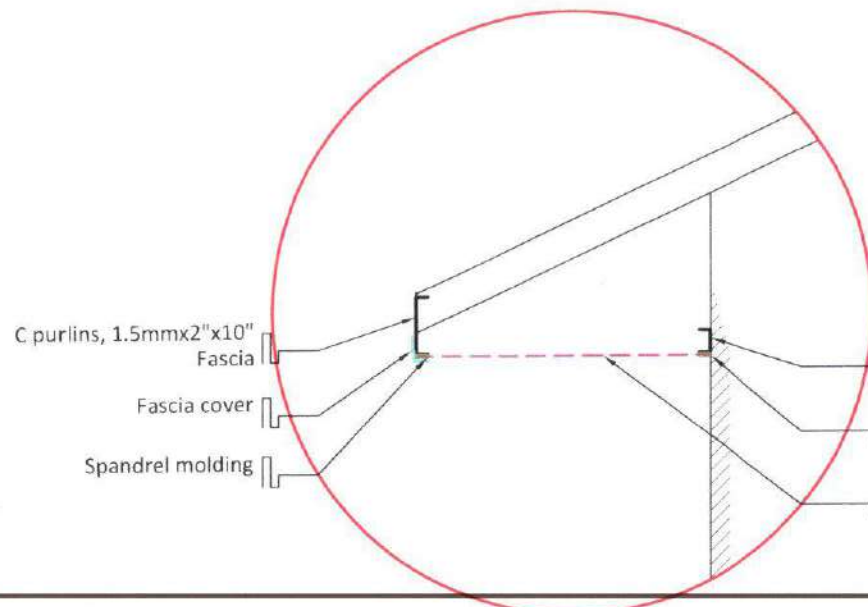
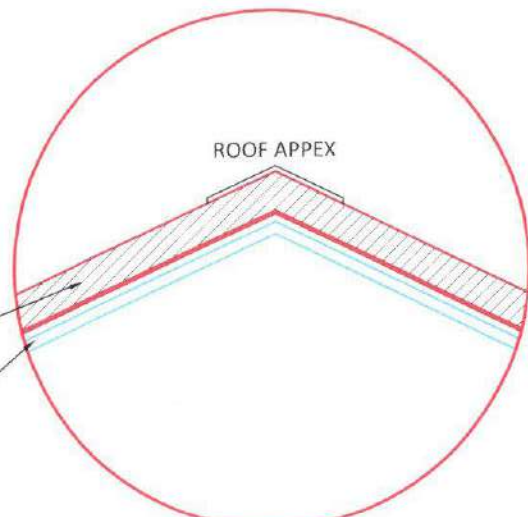

ROOF ACCESSORIES SPOT DETAIL
 SCALE 1 : 3 3

Note:
 -Use pvc conduit, 1/2"
 -Use elec. molding for exposed wires, 3/4"
 -Use #14 THHN stranded wire

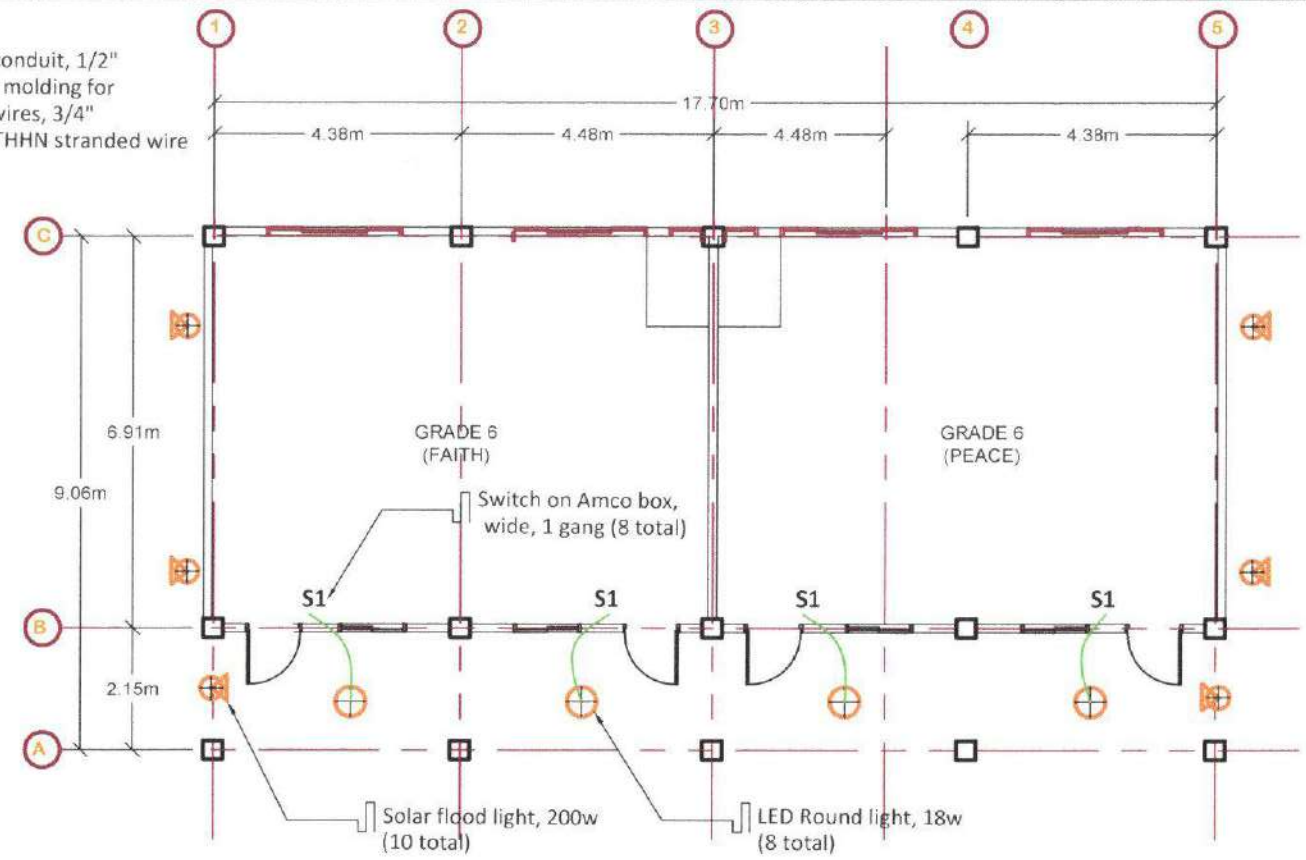

FIRST FLOOR ADDITIONAL LIGHTING LAYOUT
 SCALE 1 : 1 3 3

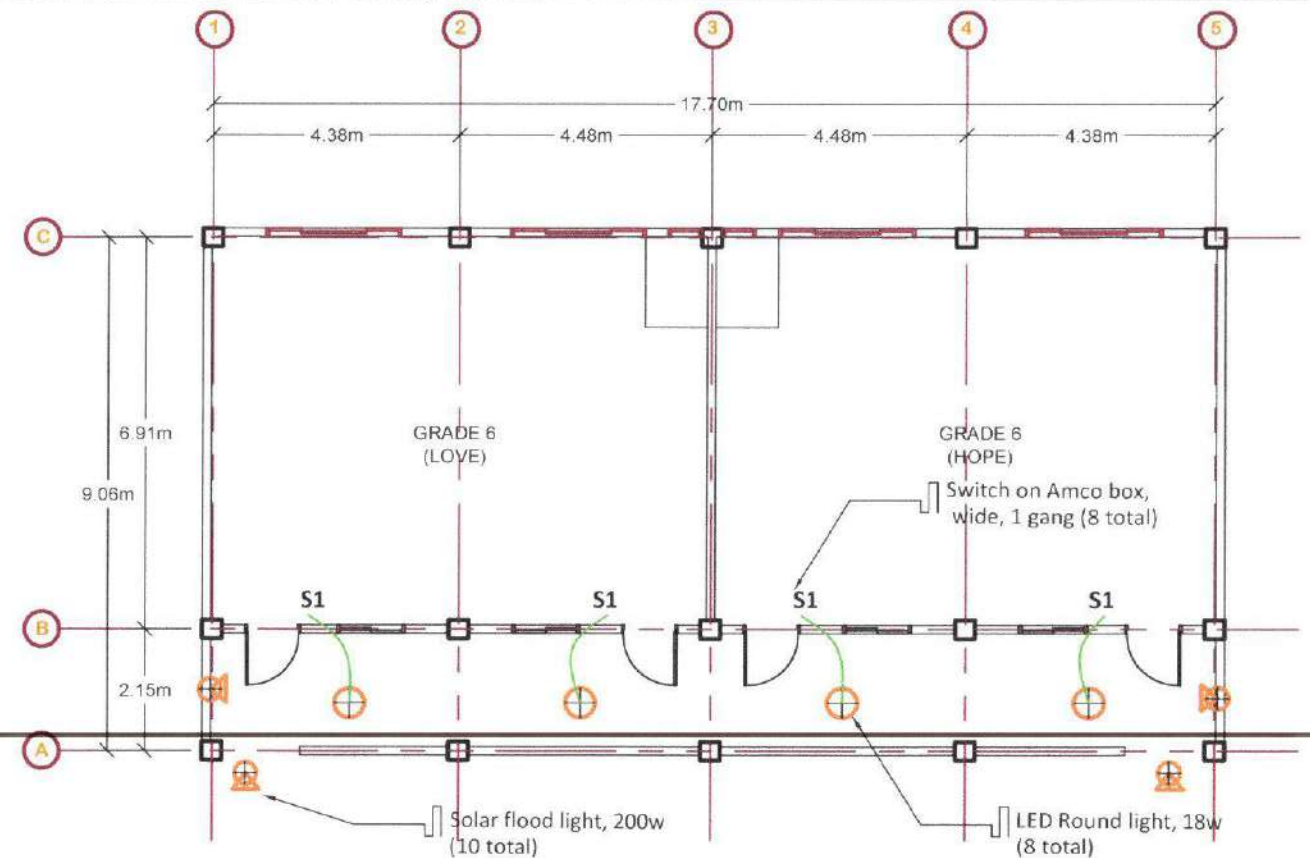

SECOND FLOOR ADDITIONAL LIGHTING LAYOUT
 SCALE 1 : 1 3 3

<p>DepEd SCHOOLS DIVISION OFFICE</p> <p>#B2 MILITARY CUTOFF RD. BAGUIO CITY</p>	<p>PROJECT TITLE & LOCATION:</p> <p>REPAIR OF CLASSROOMS AT DOÑA AURORA ELEMENTARY SCHOOL</p>	<p>PREPARED BY:</p> <p><i>Jordan B. Gas</i> JORDAN B. GAS - IB ENGINEER III</p> <p>DATE:</p>	<p>RECOMMENDING APPROVAL:</p> <p><i>Nino M. Tibangay</i> NIÑO M. TIBANGAY CHIEF, SGOD</p> <p>DATE:</p>	<p>APPROVED:</p> <p><i>Soraya T. Facundo</i> SORAYA T. FACUNDO PH.D, CESO VI OIC-SCHOOLS DIVISION SUPERINTENDENT</p> <p>DATE:</p>	<p>SHEET CONTENTS:</p> <p>-AS SHOWN</p>	<p>SHEET NO:</p> <p>5</p>
	<p>5</p>					



DEPARTMENT OF EDUCATION
SCHOOLS DIVISION OFFICE
Military Cutoff, Baguio City



PROGRAM OF WORKS
DETAILED COST ESTIMATE
(TOTAL CONSTRUCTION COST/ ABC)
REPAIR 2024 - CAR - BAGUIO CITY - 2600

PROJECT REPAIR OF CLASSROOMS DOÑA AURORA ELEMENTARY SCHOOL
SCHOOL : DOÑA AURORA ELEMENTARY SCHOOL
LOCATION : NORTH CENTRAL AURORA HILL, BAGUIO CITY
OWNER : DEPARTMENT OF EDUCATION

CONTRACT DURATION : **61 CD**

ITEM NO.	DESCRIPTION	QUANTITY	UNIT	ESTIMATED DIRECT COST	MARK-UPS IN PERCENT		TOTAL MARK-UP		VAT (5%)	TOTAL INDIRECT COST	ADJUSTED TOTAL COST	ADJUSTED UNIT COST
					OCM	PROFIT	%	VALUE				
(1)	(2)	(3)	(4)	(5)	(6)	(7)	(8)	(9)	(10)	(11)	(12)	(13)
							(6) + (7)	(5) x (8)	5% [(5) + (9)]	(9) + (10)	(5) + (11)	(12) / (3)
B.	Other General Requirements											
SPL 1	Project Billboard	1.00	Each	-				-	-	-	-	-
C.	Mobilization and Demobilization	-		-								
C.1	Mobilization and Demobilization	1.00	Ls	-				-	-	-	-	-
2.0000	Concreting Works (3000 psi)	-		-								
5 (f)	Chipping of Masonry Wall	5.26	sq m	-				-	-	-	-	-
	Finishing Works	-		-				-	-	-	-	-
5 (d)	Plain Cement Plaster Finish	16.43	sq.m	-				-	-	-	-	-
6.0000	Fabricated Materials and Hardware	-		-								
6 (b)	Removal of Window with Jamb	26.34	sq m	-				-	-	-	-	-
6 (h)	Analok frame window	30.24	sq.m	-				-	-	-	-	-
6 (i)	Window grills	28.80	sq.m	-				-	-	-	-	-
7.0000	Steel Works	-		-								
7 (j)	Metal Structure Fascia	67.00	l.m	-				-	-	-	-	-
8.0000	Roofing Works	-		-								
8 (f)	Removal of Gutter	41.00	l.m	-				-	-	-	-	-
8 (g)	Removal of Flashing	26.00	l.m	-				-	-	-	-	-
8 (d)	Fabricated Metal Roofing Accessory (Gutter)	41.00	l.m	-				-	-	-	-	-
8 (e)	Fabricated Metal Roofing Accessory (Ridge/ Hip Rolls/ Flashing/ Counter Flashing/ Valley Roll)	26.00	l.m	-				-	-	-	-	-

ITEM NO.	DESCRIPTION	QUANTITY	UNIT	ESTIMATED DIRECT COST	MARK-UPS IN PERCENT		TOTAL MARK-UP		VAT (5%)	TOTAL INDIRECT COST	ADJUSTED TOTAL COST	ADJUSTED UNIT COST
					OCM	PROFIT	%	VALUE				
9.0000	Ceiling and Carpentry Works	-		-								
9 (j)	Removal of Soffit	74.11	sq m	-				-	-	-	-	-
9 (d)	Removal of Ceiling	33.84	sq m	-				-	-	-	-	-
9 (k)	Removal of Fascia	67.00	l.m	-				-	-	-	-	-
9 (l)	PVC panel on Metal Frame Ceiling	33.84	sq.m	-				-	-	-	-	-
9 (m)	Spandrel on Metal Frame Ceiling	74.11	sq.m	-				-	-	-	-	-
10.0000	Electrical Works	-		-								
10 (a)	Conduit, Boxes and Fitting	1.00	Ls	-				-	-	-	-	-
10 (b)	Wires and Wiring Devices	1.00	Ls	-				-	-	-	-	-
10 (c)	Lighting Fixture/ Fixture	1.00	Ls	-				-	-	-	-	-
11.0000	Plumbing Works	-		-								
11 (b)	Rainwater Downspout	1.00	Ls	-				-	-	-	-	-
13.0000	Painting Works	-		-								
13 (a)	Masonry Painting	299.65	sq.m	-				-	-	-	-	-
13 (c)	Metal Painting	260.65	sq.m	-				-	-	-	-	-
	TOTAL CONSTRUCTION COST										-	

Prepared by:

Name of bidder

Item No.	Description	% of Total	Unit	Quantity	Direct Cost		Adjusted Unit Cost	Adjusted Total Cost
					Total Cost	Unit Cost		
6 (i)	Window grills		sq.m	28.80				
7.0000	Steel Works							
7 (j)	Metal Structure Fascia		l.m	67.00				
8.0000	Roofing Works							
8 (f)	Removal of Gutter		l.m	41.00				
8 (g)	Removal of Flashing		l.m	26.00				
8 (d)	Fabricated Metal Roofing Accessory (Gutter)		l.m	41.00				
8 (e)	Fabricated Metal Roofing Accessory (Ridge/ Hip Rolls/ Flashing/ Counter Flashing/ Valley Roll)		l.m	26.00				
9.0000	Ceiling and Carpentry Works							
9 (j)	Removal of Soffit		sq m	74.11				
9 (d)	Removal of Ceiling		sq m	33.84				
9 (k)	Removal of Fascia		l.m	67.00				
9 (l)	PVC panel on Metal Frame Ceiling		sq.m	33.84				
9 (m)	Spandrel on Metal Frame Ceiling		sq.m	74.11				
10.0000	Electrical Works							
10 (a)	Conduit, Boxes and Fitting		Ls	1.00				
10 (b)	Wires and Wiring Devices		Ls	1.00				
10 (c)	Lighting Fixture/ Fixture		Ls	1.00				
11.0000	Plumbing Works							
11 (b)	Rainwater Downspout		Ls	1.00				
13.0000	Painting Works							
13 (a)	Masonry Painting		sq.m	299.65				
13 (c)	Metal Painting		sq.m	260.65				
						Total Construction Cost		-

Prepared by:

_____ name of bidder